

TECHNICAL MEMORANDUM

FEASIBILITY OF FISH PASSAGE AT  
ALAMEDA CREEK DIVERSION DAM



*Prepared for*  
San Francisco Public Utilities Commission

June 2009

**URS** **HDR**



# TABLE OF CONTENTS

EXECUTIVE SUMMARY .....	ES-1
1 INTRODUCTION .....	1-1
1.1 BACKGROUND INFORMATION .....	1-1
1.2 PURPOSE.....	1-1
1.3 SCOPE.....	1-2
1.4 ORGANIZATION OF TECHNICAL MEMORANDUM .....	1-2
2 SETTING.....	2-1
2.1 ALAMEDA CREEK WATERSHED.....	2-1
2.2 UPPER ALAMEDA CREEK SUB-WATERSHED .....	2-2
2.3 STUDY AREA .....	2-2
2.3.1 Alameda Creek Upstream of Calaveras Creek .....	2-3
2.3.2 Alameda Creek Diversion Dam and Tunnel.....	2-5
2.4 STEELHEAD PRESENCE IN THE ALAMEDA CREEK WATERSHED.....	2-11
2.5 OTHER FISH SPECIES IN THE STUDY AREA.....	2-15
3 METHODOLOGY .....	3-1
3.1 BACKGROUND INFORMATION REVIEW.....	3-1
3.2 IDENTIFICATION AND ANALYSIS OF DESIGN COMPONENTS FOR FISH PASSAGE.....	3-1
3.3 EVALUATION OF THE BIOLOGICAL BENEFIT OF TWO PASSAGE OPTIONS .....	3-2
4 DESIGN COMPONENTS AND PRELIMINARY ANALYSIS .....	4-1
4.1 FISH LADDERS .....	4-2
4.2 FISH LIFTS .....	4-9
4.3 TRAP AND HAUL .....	4-9
4.4 FISH SCREENS .....	4-14
4.4.1 Screen Design Types .....	4-16
4.4.2 Potential Screen Configurations .....	4-21
5 CAPITAL AND OPERATING AND MAINTENANCE COSTS .....	5-1
5.1 CAPITAL COSTS .....	5-1
5.2 LOST WATER DIVERSION COST ESTIMATION .....	5-2
5.2.1 Reduction in Diversion Capacity due to Screening.....	5-3
5.2.2 Fish Screen Bypass Flows .....	5-6
5.2.3 Fish Ladder Operation Flows .....	5-6
5.2.4 Limitations of Water Diversion estimations.....	5-8
5.3 ANNUALIZED CAPITAL AND OPERATIONS AND MAINTENANCE COSTS.....	5-10
6 ADDITIONAL CONSIDERATIONS AND ANALYSIS.....	6-1
6.1 HABITAT AVAILABILITY.....	6-1
6.2 POTENTIAL FOR SUSTAINABILITY .....	6-2
6.3 ENVIRONMENTAL CONSIDERATIONS .....	6-6
6.4 SELECTION OF PREFERRED PASSAGE DESIGN COMPONENTS.....	6-7
7 EVALUATION OF THE BIOLOGICAL BENEFIT OF TWO PASSAGE OPTIONS .....	7-1
7.1 ACDD FISH LADDER OPTION.....	7-1
7.1.1 Provide Access to Additional Quantity of Habitat to Increase Natural Production .....	7-2

7.1.2	Contribute to Species Recovery Through Increased Natural Production.....	7-2
7.1.3	Provide Access to Historical Habitat.....	7-2
7.1.4	Protect or Enhance the Genetic Integrity and/or Distinctness of Stocks .....	7-2
7.1.5	Reduce Risk of Extinction Through Increased Natural Production and Creation of Additional Independent Populations .....	7-4
7.2	OHLONE TRAP AND HAUL OPTION .....	7-4
7.2.1	Provide Access to Additional Quantity of Habitat to Increase Natural Production .....	7-5
7.2.2	Contribute to Species Recovery Through Increased Natural Production.....	7-5
7.2.3	Provide Access to Historical Habitat.....	7-5
7.2.4	Protect or Enhance the Genetic Integrity and/or Distinctness of Stocks .....	7-5
7.2.5	Reduce Risk of Extinction Through Increased Natural Production and Creation of Additional Independent Populations .....	7-5
8	CONCLUSION.....	8-1
9	REPORT PREPARATION.....	9-1
9.1	LIST OF PREPARERS .....	9-1
9.2	ACKNOWLEDGMENTS .....	9-2
10	REFERENCES .....	10-1

## Appendices

Appendix A	Cost Estimate Backup Calculations
Appendix B	Arroyo Hondo – Alameda Creek Flow Model Development
Appendix C	Technical Information on Minimum Viable Population Size

## Tables

Table 2-1	Approximate Acreage of Sub-Watersheds and Basins Within the Alameda Creek Watershed
Table 2-2	Description of Alameda Creek Diversion Dam and Appurtenant Works
Table 2-3	SFPUC Proposed Instream Flow Schedule
Table 4-1	Steelhead Passage Element Timing
Table 5-1	Capital Costs of ACDD Passage Design Components
Table 5-2	Comparison of Predicted Diversion Amounts with and without Screening
Table 5-3	ACDD Fish Passage Design Components Annualized Costs
Table 5-4	ACDD Fish Passage Options and Conceptual Annualized Cost Comparison

## Figures

Figure 1-1	Alameda Creek Watershed
Figure 2-1	Study Area and Vicinity
Figure 2-2	Daily Average Discharge at the Upper Alameda Creek Flow Gage, 1997 Water Year
Figure 2-3	Alameda Creek Diversion Dam
Figure 2-4	Alameda Creek Diversion Dam Plan
Figure 2-5	Outlet of the Alameda Creek Diversion Tunnel at Calaveras Reservoir
Figure 2-6	SFPUC Proposed Instream Flow Schedule and WSIP Program Mitigation Measure Flow
Figure 4-1	Example Fish Ladder Photos
Figure 4-2	Two Potential Fishway Locations at ACDD
Figure 4-3	Example Fish Lift Photos
Figure 4-4	Example Fish Transport Truck Photos
Figure 4-5	Haul Route from Confluence to above ACDD
Figure 4-6	Rotary Drum Screen
Figure 4-7	Vertical Traveling Screen
Figure 4-8	Schematic Diagram of Typical Vertical Flat-Plate Fish Screen Installation
Figure 4-9	Typical Vertical Flat-Plate Screen
Figure 4-10	Typical Inclined Flat-Plate Screens
Figure 4-11	Vertical Flat-Plate Fish Screen in Operation
Figure 4-12	Horizontal Downward-Sloping Flat Plate Screen
Figure 4-13	Screen System in the Sediment Channel
Figure 4-14	Screen System Outside of the Sediment Channel
Figure 5-1	Flow versus Required Screen Area
Figure 5-2	Potential Reduction in Diversions Due to Reduced Maximum Diversion Capacity with Screens
Figure 5-3	Water Potentially Required for a Fish Ladder and Fish Screen Bypass at ACDD
Figure 6-1	Upper Alameda Creek Basin

## List of Acronyms

ACDD	Alameda Creek Diversion Dam
ACDT	Alameda Creek Diversion Tunnel
ACFCWCD	Alameda County Flood Control and Water Conservation District
ACFRW	Alameda Creek Fisheries Restoration Workgroup
ACWD	Alameda County Water District
BART	Bay Area Rapid Transit
CCC	Central California Coast
CDFG	California Department of Fish and Game
CDRP	Calaveras Dam Replacement Project
CFR	Code of Federal Regulations
cfs	Cubic feet per second
CRF	Capital Recovery Factor
DPS	Distinct Population Segment
DSOD	Division of Safety of Dams
EBRPD	East Bay Regional Parks District
ESA	(Federal) Endangered Species Act
ETJV	EDAW-Turnstone Joint Venture
fps	Feet per second
MG	Million gallons
HDR	HDR Engineering, Inc.
HDR SWRI	HDR Engineering, Inc. Surface Water Resources, Inc.
MOU	Memorandum of Understanding
NMFS	National Marine Fisheries Service
O&F	Overhead and Fee
O&M	Operation and maintenance
PEIR	Program Environmental Impact Report
PG&E	Pacific Gas & Electric Company
SFPD	San Francisco Planning Department
SFPUC	San Francisco Public Utilities Commission
SFWD	San Francisco Water Department
URS	URS Corporation
USACE	U.S. Army Corps of Engineers
USGS	U.S. Geological Survey
VSP	Viable Salmonid Population
WDFW	Washington Department of Fish and Wildlife
WSIP	Water System Improvement Program

## EXECUTIVE SUMMARY

This technical memorandum identifies conceptual-level fish passage options at the Alameda Creek Diversion Dam (ACDD) and assesses the feasibility of implementing passage to benefit steelhead when they are restored to the Alameda Creek Watershed.

## BACKGROUND

Steelhead historically had access to the Alameda Creek Watershed, but upstream migration from the San Francisco Bay has been blocked for decades by a number of artificial barriers. The San Francisco Public Utilities Commission (SFPUC) is a participant in the Alameda Creek Fisheries Restoration Workgroup, which is working to restore steelhead to the Alameda Creek Watershed. In conjunction with other fisheries enhancement activities, the SFPUC removed Niles and Sunol dams from Alameda Creek in 2006. As a result of ongoing efforts to remedy the barriers to passage, anadromous steelhead will be restored to the Alameda Creek Watershed.

ACDD is a 31-foot-tall concrete structure that is an impassable barrier to upstream fish migration. It is located approximately 28 miles upstream of San Francisco Bay and approximately 11 miles downstream of the upper extent of Alameda Creek. The SFPUC uses the ACDD and the Alameda Creek Diversion Tunnel (ACDT) to divert water during the wet season from a 21,000-acre catchment area within the Upper Alameda Creek Basin to Calaveras Reservoir, for impoundment and subsequent use as municipal water supply.

## ANALYSIS OF FISH PASSAGE AT ACDD

Fish passage devices and methods used at other dams were reviewed and evaluated to determine the feasibility of fish passage at ACDD. This review included literature on fish physiological responses to handling, behavioral responses to devices, steelhead reproductive success, steelhead life history characteristics, and general fish passage concepts. In the analysis, design features (*design components*) for fish immigration and emigration were identified and evaluated, then analyzed in complete immigration and emigration combinations (*options*).

A number of design components for fish passage were identified and evaluated to determine whether they could provide passage for steelhead at ACDD in a manner consistent with the biological needs of the species. It was determined that fish screens would be required to protect steelhead from entrainment at the ACDT with implementation of any type of fish passage at ACDD. Installation of fish screens would require modification of the ACDD to provide bypass flows that would protect steelhead from impingement at the screened diversion, and that would simultaneously provide downstream passage for emigrating steelhead.

For adult immigration, the following design components were considered:

- Fish lifts
- Trap and haul
- Fish ladders

Fish lifts were determined to be unsuitable at ACDD because they are non-volitional, require large inputs of power, and would achieve the same effect as a ladder, which is a more practical component.

Trap and haul was also evaluated, and was determined to be potentially suitable for steelhead passage at ACDD due to its ability to move immigrating fish past ACDD, and past Little Yosemite. Little Yosemite is a high-gradient reach of Alameda Creek with exposed bedrock and large boulders approximately 2 miles downstream of ACDD that may limit the ability of future steelhead to access the reach immediately below the diversion dam. Trap and haul at ACDD would involve trapping immigrating adult steelhead below the dam (or below Little Yosemite) and hauling them to a release site above ACDD. Trap and haul would not require collection or relocation of emigrating steelhead because fish screen bypass flows would provide safe downstream passage at ACDD and Little Yosemite is not expected to significantly affect potential steelhead emigration. Due to the uncertainty of passage conditions at Little Yosemite, trap and haul is retained in the analysis as a technologically feasible option for providing passage.

Fish ladders were determined to be suitable for use at ACDD, contingent upon steelhead being able to immigrate through Little Yosemite. The advantage of fish ladders over fish lifts and trap and haul is that they provide volitional passage with minimal handling and associated stress to the fish, compared to other fish passage methods. Two potential ladder configurations were evaluated for use at ACDD, a short fishway that would provide an exit for fish immediately above ACDD, and a long fishway that would provide an exit for fish approximately 400 feet farther upstream, above the hydrologic influence of the dam. Both fishways would involve construction around ACDD on the right bank of Alameda Creek; the near-vertical rock wall and presence of existing facilities limit the feasibility of constructing a fish ladder on the left bank of the channel. Although both configurations are potentially feasible, a long fishway that joins Alameda Creek upstream of the hydraulic influence of ACDD may offer greater control over the flows that pass down the fishway than a short fishway that joins Alameda Creek immediately upstream of the dam. Therefore, the long fishway concept is carried forward for further analysis in the technical memorandum.

Design components that were determined to be suitable for providing fish passage at the ACDD based on the first tier of analysis were then evaluated based on estimated capital, operations, and maintenance costs. The estimated total capital cost of design components associated with a fish ladder passage option and a trap and haul passage option are of a similar order of magnitude (\$23.7 and \$21.7 million, respectively), more than half of which is the estimated cost of fish screens at the ACDD. Including the estimated water costs, the order-of-magnitude capital and operating and maintenance cost for fish passage with screening at ACDD, annualized over a period of 30 years, is estimated at approximately \$4 million annually for either a fish ladder or trap and haul passage option. In both cases, more than \$3 million of the estimated annual cost is associated with screens. A significant portion of the annual cost of passage at the ACDD is estimated to be lost water diversion opportunity cost.

This memorandum also presents preliminary analysis of the potential biological benefit of providing passage for steelhead at ACDD. Portions of Alameda Creek above ACDD do not have perennial flow; therefore, above ACDD fish habitat is limited during the dry season. A comprehensive survey of available habitat above ACDD has not been conducted, and it is unknown whether spawning and juvenile rearing habitat above ACDD is sufficient to support a self-sustaining population. If the quantity and quality of habitat are not sufficient to support a self-sustaining population above ACDD, provision of passage could still contribute to a steelhead metapopulation in the Alameda Creek Watershed, if additional subpopulations are established in other reaches.

## CONCLUSIONS

An effort to establish steelhead access above the ACDD would have a reasonable probability of success based on this preliminary analysis. While a fish ladder is a technologically feasible option for



providing volitional passage for steelhead at ACDD, the performance of a fish ladder would depend upon passage conditions for immigrating steelhead in the Little Yosemite reach of Alameda Creek. If Little Yosemite significantly limits steelhead from reaching a fish ladder at ACDD, trap and haul from below Little Yosemite to above ACDD could also provide passage, although long-term success of such passage would depend on ongoing institutional commitment and funding. However, the volitional passage option of a fish ladder is preferable to non-volitional options such as trap and haul.

While fish passage is technologically feasible, the ability of steelhead to pass Little Yosemite when they return to the Upper Alameda Creek Basin should be studied prior to implementing either fish passage option evaluated in this memorandum. Given the uncertainty of passage conditions at Little Yosemite, it is important to understand which option would provide the greatest benefit to the species. When steelhead return to the base of Little Yosemite, it will be possible to observe and directly evaluate passage at this feature. The results of these observations could be used to refine analysis regarding the potential to provide passage for immigrating steelhead at ACDD, along with the completion of detailed surveys of potential steelhead habitat above ACDD, in cooperation with upstream landowners, which would allow for a more accurate assessment of the potential biological benefit of steelhead passage.



# 1 INTRODUCTION

## 1.1 BACKGROUND INFORMATION

The San Francisco Public Utilities Commission (SFPUC) has been working with other stakeholders since the late 1980s to restore steelhead (*Oncorhynchus mykiss*) to the Alameda Creek Watershed (TAC, 1989). In conjunction with other fisheries enhancement actions, the SFPUC removed Niles and Sunol dams from Alameda Creek in 2006 and is completing a Habitat Conservation Plan that includes steelhead as a covered species (SFPUC, 2009a). The SFPUC is also a member of the Alameda Creek Fisheries Restoration Workgroup, which is working to restore steelhead to the Alameda Creek Watershed. The Alameda Creek Fisheries Restoration Workgroup is composed of a broad range of stakeholders, including representatives from the National Marine Fisheries Service (NMFS) and the California Department of Fish and Game (CDFG).

Steelhead entry into the Alameda Creek Watershed from the ocean via San Francisco Bay is currently blocked by various water development and other projects in lower Alameda Creek (TAC, 1989; ETJV and ESA-Orion Joint Venture, 2008; SFPUC, 2008a). When migrating from the ocean to spawn in freshwater, adult steelhead, which are listed as threatened<sup>1</sup> under the federal Endangered Species Act, are sometimes present in low numbers below the Alameda County Flood Control and Water Conservation District (ACFCWCD) grade control structure (known as the BART weir), the first complete barrier to upstream fish migration in Alameda Creek (Figure 1-1). Efforts are underway to create passage for steelhead at the BART weir and other barriers to migration.

The SFPUC operations are located within the Upper Alameda Creek Sub-Watershed (Figure 1-1), where the SFPUC operates San Antonio and Calaveras reservoirs and associated water delivery facilities. Construction of the Alameda Creek Diversion Dam and Tunnel began in 1925 to secure additional sources of water from the Upper Alameda Creek Sub-Watershed for impoundment in Calaveras Reservoir. The SFPUC began diverting water from the Upper Alameda Creek Basin with the completion of the diversion dam and tunnel in 1931 (SFPUC, 2004).

Ongoing operation of SFPUC facilities influences fish access to stream channel habitats within the Upper Alameda Creek Sub-Watershed. Once steelhead regain access to the watershed through the construction of fish passage facilities in the Lower Alameda Creek Sub-Watershed (ACFCWCD and ACWD, 2007) and re-enter the upper sub-watersheds, the Alameda Creek Diversion Dam (ACDD) will present any steelhead that successfully immigrate past Little Yosemite with an impassable barrier to upstream migration. This memorandum, in conjunction with three other studies (URS and HDR, 2009a, 2009b, and 2009c), provides information regarding upstream migration conditions in the Upper Alameda Creek Sub-Watershed.

## 1.2 PURPOSE

The SFPUC has retained URS Corporation and HDR (including both HDR|SWRI and HDR|FishPro's Fishery Design Center) to provide professional fisheries and engineering services to evaluate the feasibility of providing fish passage and screening for anadromous steelhead at the ACDD. In conjunction with ongoing efforts to remedy the barriers to passage, it is anticipated that a run of anadromous steelhead will be restored to the Alameda Creek Watershed (ETJV and ESA-Orion Joint Venture, 2008). This technical memorandum describes the general design criteria, evaluates

---

<sup>1</sup> Below natural and manmade impassable barriers, Central California Coast distinct population segment naturally spawned anadromous steelhead (*Oncorhynchus mykiss*) are listed as threatened under the federal Endangered Species Act (NMFS, 2006).

conceptual-level options, and assesses the feasibility of providing passage and fish screening for steelhead above ACDD.

### 1.3 SCOPE

The scope of work for this effort includes examining the feasibility of providing future restored populations of anadromous steelhead, once they are re-established in the Alameda Creek Watershed, with a means of passage at ACDD and the co-located Alameda Creek Diversion Tunnel (ACDT). The evaluation of fish passage includes the consideration of construction of fish ladders, fish lifts, trap and haul, and other possible options for fish passage at ACDD. Successful passage would require screening at the ACDT to prevent steelhead entrainment and subsequent transport to Calaveras Reservoir. This evaluation includes consideration of the feasibility, cost and other constraints, and benefits of providing fish passage.

Three other technical memoranda, which are in preparation, examine passage conditions at rock features in the stream reaches in the Upper Alameda Creek Sub-Watershed; study and estimate steelhead migration flows in the reach of Alameda Creek at the Sunol quarries; and assess the technical feasibility of providing passage at SFPUC's proposed replacement Calaveras Dam.

### 1.4 ORGANIZATION OF TECHNICAL MEMORANDUM

The organization of the Feasibility of Fish Passage at Alameda Creek Diversion Dam Technical Memorandum is as follows:

- Section 1 provides background information and introduces the purpose and scope of the Feasibility of Fish Passage at Alameda Creek Diversion Dam Technical Memorandum.
- Section 2 describes existing hydrology and historic and existing steelhead presence in the Alameda Creek Watershed, and defines the study area for this technical memorandum.
- Section 3 describes the methodology used in this technical memorandum.
- Section 4 describes and preliminarily analyzes the design components that would be part of fish passage at ACDD.
- Section 5 identifies and estimates capital and operating and maintenance costs, including water costs, potentially associated with passage at ACDD.
- Section 6 provides a discussion of additional factors, beyond the preliminary analysis in Section 4 and the cost analysis in Section 5, that warrant consideration when evaluating fish passage design components for ACDD at a conceptual level.
- Section 7 describes two potential fish passage options and provides an analysis of the potential for fish passage at ACDD to meet specific passage goals.
- Section 8 presents the conclusions reached in this technical memorandum.
- Section 9 lists the preparers of this technical memorandum.
- Section 10 lists the references used in preparation of this technical memorandum.
- Appendix A provides cost estimate calculations; Appendix B describes the selection of a flow model for Alameda Creek; and Appendix C provides information on viable population sizes for salmonids.

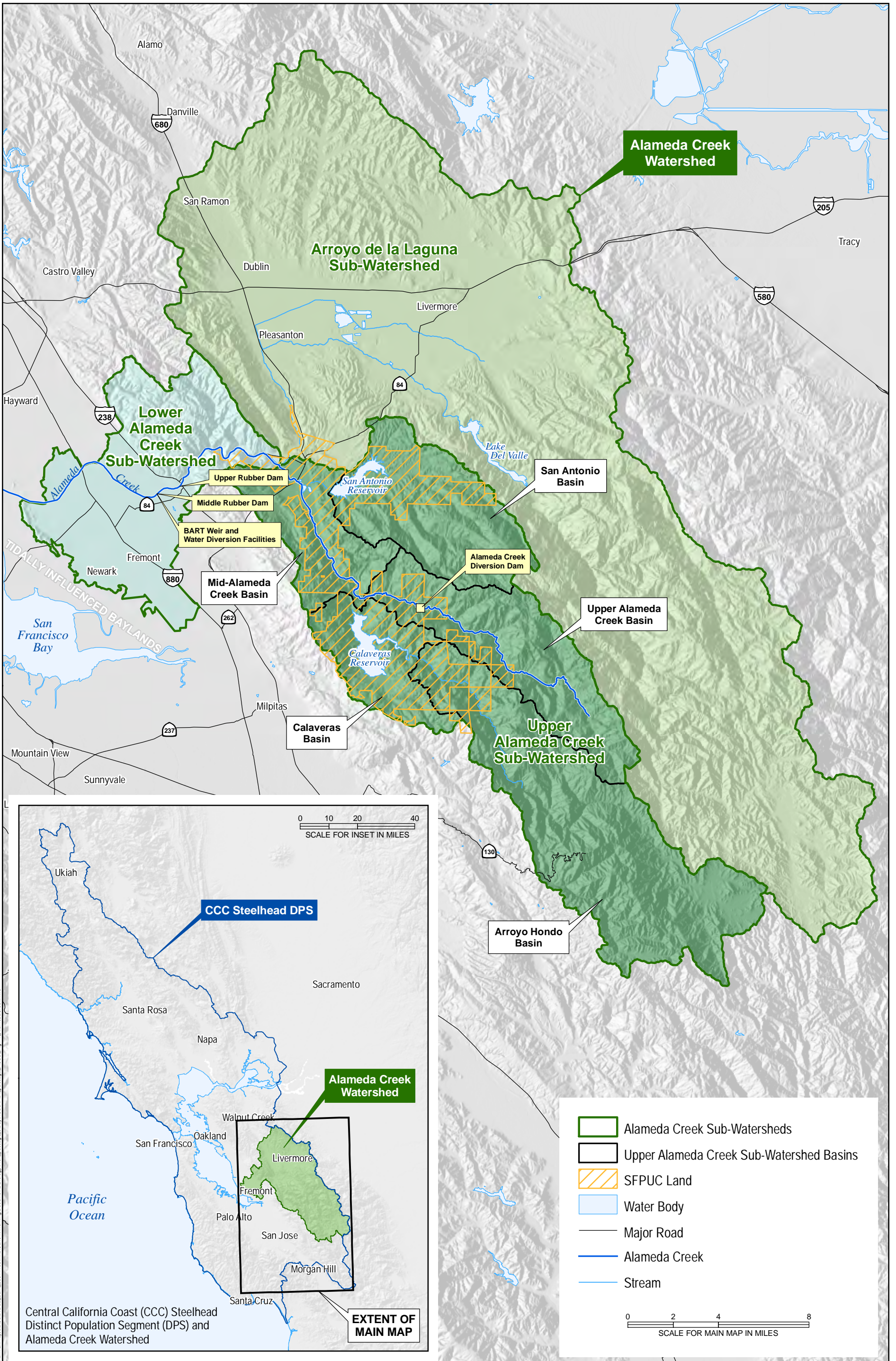

URS Corp - Oakland, CA - C:\Raumann\Projects\Calaveras\_Dam\_26814408\Map\Current Working Documents\Biology\Fish\_passage\_study\ACDD\Fish\_passage\_ACDD\_Fig1-1\_AlamedaCreek.mxd



## 2 SETTING

ACDD and the ACDT are the facilities used to divert water from Alameda Creek to Calaveras Reservoir (Figure 2-1). These diversion facilities are located within the Upper Alameda Creek Basin. Table 2-1 lists the approximate acreages of the Alameda Creek Watershed, its sub-watersheds, and the basins within the Upper Alameda Creek Sub-Watershed that comprise the setting for this technical memorandum.

<b>Watershed</b>	<b>Sub-Watershed</b>	<b>Basin</b>	<b>Acreage<sup>1</sup></b>
Alameda Creek			440,000
	Arroyo de la Laguna		270,000
	Upper Alameda Creek		130,000
		Arroyo Hondo	51,000
		Upper Alameda Creek	26,000
		San Antonio	25,000
		Mid-Alameda Creek	15,000
		Calaveras	13,000
	Lower Alameda Creek		40,000
Note: <sup>1</sup> Acreages reported for watersheds in this technical memorandum are based on CalWater data, available at <a href="http://cain.ice.ucdavis.edu/calwater/caldata.html">http://cain.ice.ucdavis.edu/calwater/caldata.html</a> .			

This section describes the Alameda Creek Watershed (Section 2.1); the Upper Alameda Creek Sub-Watershed (Section 2.2); and the study area, including Alameda Creek and ACDD, ACDT, and their infrastructure components (Section 2.3). This section also provides a discussion of historic and current presence of steelhead in the Alameda Creek Watershed (Section 2.4) and identifies other fish species present in the study area (Section 2.5).

### 2.1 ALAMEDA CREEK WATERSHED

The Alameda Creek Watershed (Figure 1-1), at approximately 440,000 acres, is the largest tributary to the South San Francisco Bay Estuary. It drains the interior hills and valleys east of San Francisco Bay, including the southwestern slopes of the Diablo Range and the Livermore-Amador and Sunol valleys, before cutting through the East Bay hills via Niles Canyon and flowing across its largely developed alluvial fan and floodplain. Alameda Creek, the stream for which the watershed is named, flows approximately 39 miles before draining into the southeastern portion of San Francisco Bay, just north of the Highway 84 Bridge.

Average annual rainfall in the watershed varies from 24 inches on Mount Hamilton, the highest peak in the watershed at an elevation of 4,400 feet above sea level, to 15 inches near the Bay margin in Fremont. Unlike California watersheds that originate high in the Sierra Nevada Mountains, Alameda Creek Watershed does not accumulate snowpack in winter, and most of its streams are ephemeral, drying completely or to a series of intermittent pools before they are refilled by winter rains.

Alameda Creek Watershed has been modified extensively for purposes of flood control and water supply, and contains three major reservoirs (Calaveras, San Antonio, and Del Valle). The Lower reaches of Alameda Creek near Fremont have been modified extensively for flood control and water supply. Roughly 3,000,000 residents of the Bay Area rely on Alameda Creek for clean drinking water (SFEI, 2009). In addition to being managed for the growing urban area of Livermore, Dublin, Pleasanton, and Fremont, the watershed is managed for grazing, equestrian facilities, nurseries, and, more recently, vineyards.

Alameda Creek Watershed is composed of three sub-watersheds (Figure 1-1; Table 2-1). The largest sub-watershed is the Arroyo de la Laguna Sub-Watershed, which at approximately 270,000 acres drains more than 60 percent of the total watershed and contains the major reservoir, Lake Del Valle. The Arroyo de la Laguna Sub-Watershed would not be directly influenced by fish passage at ACDD.

The Upper Alameda Creek Sub-Watershed is the second largest of the three sub-watersheds, which at approximately 130,000 acres drains just less than 30 percent of Alameda Creek Watershed. The Upper Alameda Creek Sub-Watershed contains the ACDD and ACDT, the subject of this fish passage technical memorandum, and it also contains Calaveras and San Antonio reservoirs (Figure 1-1).

The Lower Alameda Creek Sub-Watershed is the smallest sub-watershed; it drains the lower area of approximately 40,000 acres, or 10 percent of the area of the entire Alameda Creek Watershed.

## 2.2 UPPER ALAMEDA CREEK SUB-WATERSHED

The ACDD and ACDT are located in the approximately 26,000-acre Upper Alameda Creek Basin, which is the second largest of five basins in the Upper Alameda Creek Sub-Watershed (Figure 1-1; Table 2-1). Alameda Creek is the main stream draining the Upper Alameda Creek Basin. Despite being the namesake of the entire Alameda Creek Watershed, this portion of Alameda Creek typically does not have perennial flow, but rather is an intermittent stream that dries to a series of isolated pools and sections of wetted channel during the dry season (Hagar and Paine, 2008).

Wet season flows from the Upper Alameda Creek Basin are diverted via the ACDT to Calaveras Reservoir, located at the confluence of Calaveras Creek and Arroyo Hondo basins. Calaveras Creek, an intermittent stream, drains the Calaveras Basin. It is the smallest basin in the sub-watershed, consisting of approximately 13,000 acres. Arroyo Hondo, a perennial stream, drains the approximately 51,000-acre Arroyo Hondo Basin, the largest basin in the sub-watershed.

The Upper Alameda Creek Sub-Watershed also contains the approximately 25,000-acre San Antonio Basin, which drains into San Antonio Reservoir, and the approximately 15,000-acre Mid-Alameda Creek Basin, which is below both the Calaveras and San Antonio reservoirs (Figure 1-1; Table 2-1).

## 2.3 STUDY AREA

The focus of this technical memorandum is to evaluate the feasibility and benefit of providing fish passage at the ACDD (specifically steelhead, see Section 2.5). Though completion of habitat surveys on SFPUC and non-SFPUC properties above ACDD were not within this scope of work, of direct relevance to this technical memorandum are the streams and facilities that could be directly influenced by fish passage at ACDD, all of which lie upstream of Alameda Creek's confluence with Calaveras Creek, within the Upper Alameda Creek Basin.



During the wet season, flows from the Upper Alameda Creek Basin are diverted to Calaveras Reservoir from the ACDD via the ACDT (Figure 2-1), with peak flows passing over ACDD (Section 2.3.2).

Calaveras Reservoir would not be directly affected by fish passage at ACDD, and is therefore not considered part of the study area for this technical memorandum. Features that could potentially be directly influenced by fish passage at ACDD are described in the following sections. These features are Alameda Creek upstream of the Calaveras Creek confluence (Section 2.3.1), a stream reach that contains potential barriers to future steelhead immigration (Little Yosemite) (Section 2.3.1.1), the ACDT (Section 2.3.2.1), and the ACDD and its appurtenant works (Section 2.3.2.2).

### 2.3.1 ALAMEDA CREEK UPSTREAM OF CALAVERAS CREEK

The portion of Alameda Creek above the confluence with Calaveras Creek is of direct relevance to this technical memorandum, as this is the reach of the creek that could potentially be directly influenced by fish passage at ACDD.

Flows above ACDD are not impeded by major dams, and are best characterized as flashy, rising rapidly following precipitation events and then quickly subsiding once precipitation ceases (Figure 2-2). The portion of Alameda Creek above the confluence with Calaveras Creek typically does not have perennial flow (SFPUC, 2007; Hagar and Paine, 2008), and conditions in the creek can vary dramatically depending on recent precipitation (Figure 2-3). Flows recorded at the U.S. Geological Survey (USGS) upper Alameda Creek gage (Gage Station 11172945; Figure 2-1) range from zero (periods when there is no measurable flow occur during most years) up to 3,390 cubic feet per second (cfs), recorded on January 9, 1995 (USGS, 2009)<sup>2</sup>. Summer temperatures are higher and annual rainfall is somewhat lower than coastal streams draining directly to the Pacific Ocean (Gunther et al., 2000).

#### 2.3.1.1 LITTLE YOSEMITE

Between ACDD and the confluence with Calaveras Creek, Alameda Creek flows through a reach known as Little Yosemite, located approximately 2.6 miles downstream of ACDD and 0.2 mile upstream of Calaveras Creek (Figure 2-1). The Little Yosemite reach of Alameda Creek is a high gradient, approximately 0.2-mile-long section of stream channel with exposed bedrock and large boulders that present potential impediments to fish immigration. These features consist of boulder cascades, turbulent cascades, and falls. The large boulders resting in the creek channel at Little Yosemite are likely the remains of a landslide mass that moved down the north canyon wall from about 600 feet above the creek (URS, 2009).

In a separate study using a methodology modified from Powers and Orsborn (1985) (URS and HDR, 2009b), two of these features, one 7.9-foot and one 9.5-foot waterfall, are identified as impassible to adult steelhead immigration in low to moderate flows (flows less than 100 cfs). However, in high flow conditions, which is when immigration would be expected, Little Yosemite may be passable. The ability of steelhead to pass Little Yosemite could be determined through surveys of future steelhead immigration. Little Yosemite and future steelhead immigration are further addressed in Section 6.1.

---

<sup>2</sup> The period of record for this gage is from October 1994 to the present (USGS, 2009).

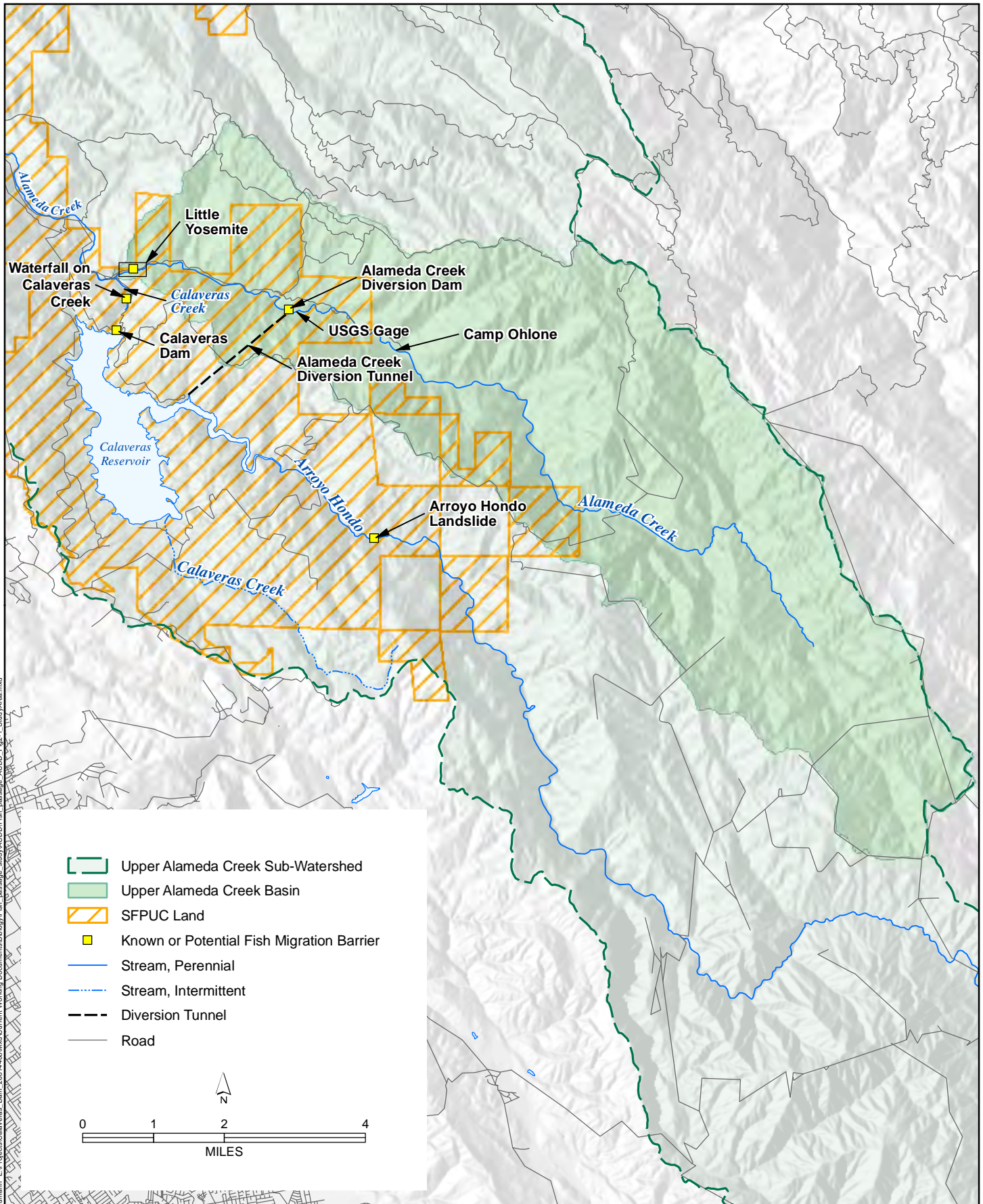

URS Corp. - Oakland CA - C:\Raumann\_L\Projects\Calaveras\_Dam\_20814.dwg\Current Working Documents\B\body\Fish\_passage\_study\ACDD\Fish\_passage\_ACDD\_Fig2-1\_StudyArea.mxd

### Study Area and Vicinity

Feasibility of Fish Passage at Alameda Creek Diversion Dam  
 Technical Memorandum

June 2009

Figure 2-1

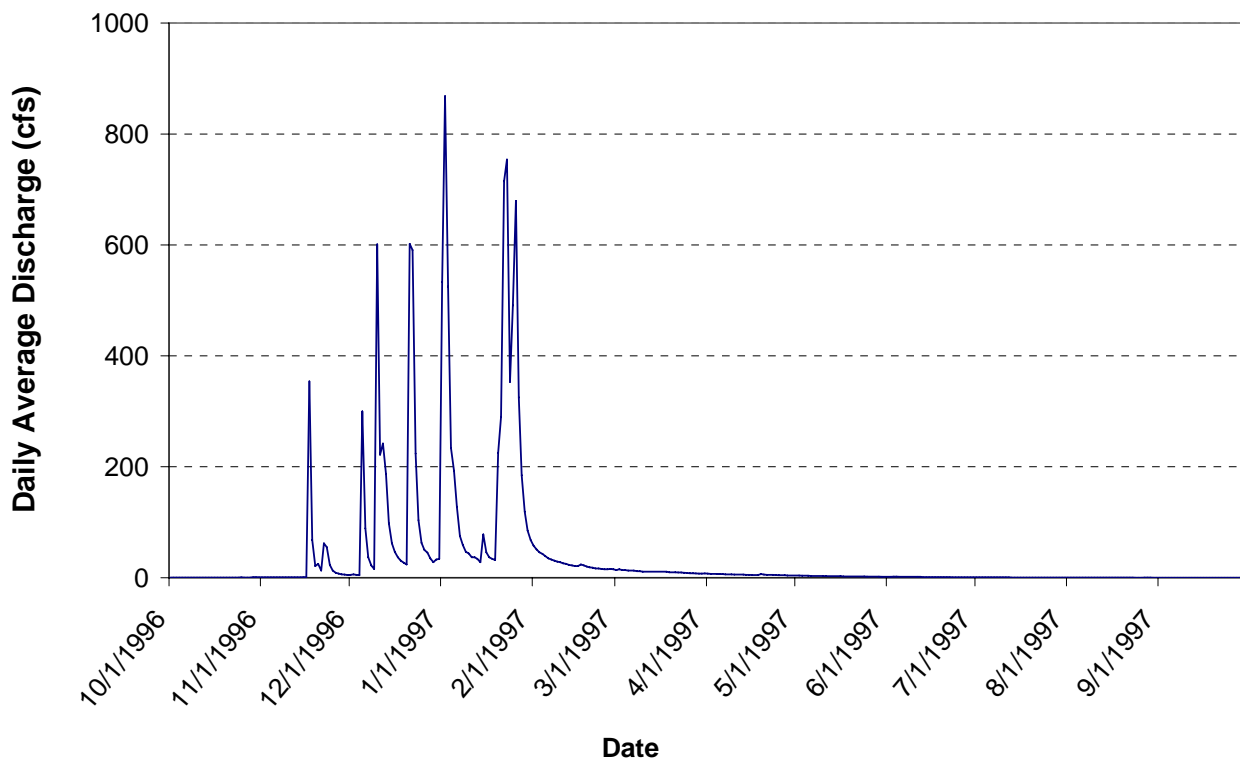

**Figure 2-2**  
**Daily Average Discharge at the Upper Alameda Creek Flow Gage, 1997 Water Year<sup>3</sup>**

### 2.3.2 ALAMEDA CREEK DIVERSION DAM AND TUNNEL

The ACDD is located on Alameda Creek approximately 28 miles upstream of San Francisco Bay and approximately 11 miles downstream of the upper extent of Alameda Creek (Figure 1-1). Together, the ACDD and ACDT are used to divert water from the Upper Alameda Creek Basin to Calaveras Reservoir for impoundment (Figure 2-3). The catchment area above ACDD is approximately 21,000 acres, compared to the approximately 26,000-acre total area of the entire basin. The inlet to the ACDT is located in the left abutment of the ACDD (facing downstream) behind a grated structure (trash rack) that prevents large debris from entering the diversion. The dam is an impassable barrier to upstream steelhead migration. A plan view diagram of the ACDD is presented in Figure 2-4.

The ACDD is located in a remote area that is only accessible via a dirt road, portions of which traverse the Sunol Wilderness administered by the East Bay Regional Park District. The left side of ACDD is built up against a steep, natural rock wall. Another important consideration of the site is the absence of electrical power. No grid electrical power is available at the site; the nearest grid electrical power is roughly 3 miles away. ACDT and ACDD are discussed in more detail in the following sections.

<sup>3</sup> 1997 water year is characterized as wet (Appendix B).

(a)



(b)



Alameda Creek Diversion Dam (a) during the dry season, and (b) during high flows sufficient to spill over the dam crest.

### Alameda Creek Diversion Dam

Feasibility of Fish Passage at Alameda Creek Diversion Dam  
Technical Memorandum

June 2009

Figure 2-3

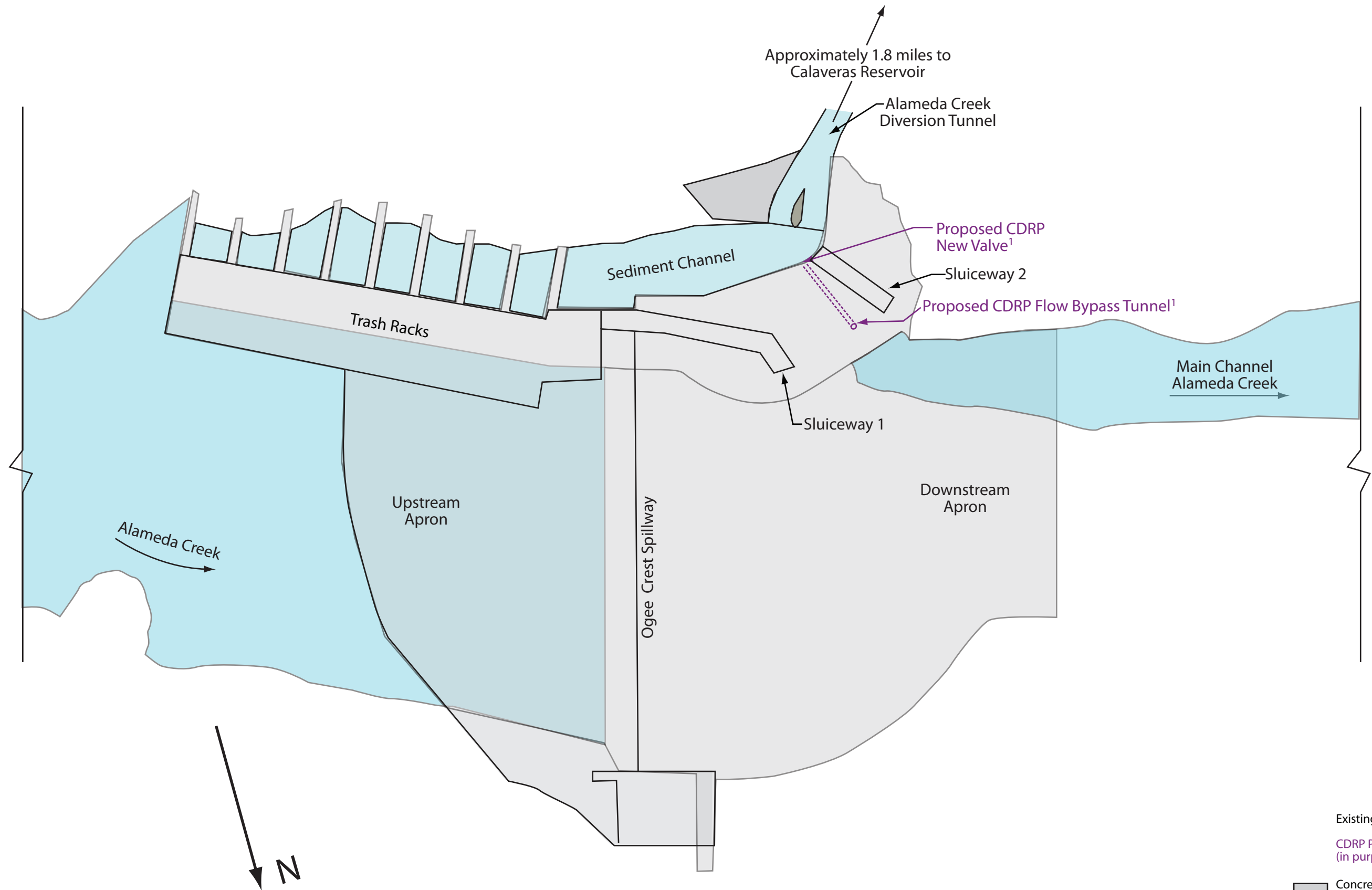

Plan  
Not to scale

- Existing Features (in black)
- CDRP Proposed Features (in purple)
- Concrete Diversion Dam Structure
- Alameda Creek

<sup>1</sup>Based on URS 2008 and SFPUC 2008a



### 2.3.2.1 ALAMEDA CREEK DIVERSION TUNNEL

The ACDT conveys surface water that is diverted from the Upper Alameda Creek Basin at the ACDD to Calaveras Reservoir. The ACDT is approximately 1.8 miles in length with an estimated maximum flow capacity of 650 cfs. Gates are used to shut off flow into the tunnel when necessary. The entrance to the ACDT at ACDD has an elevation of approximately 892 feet (measured at the bottom or “invert” to the tunnel opening). The outlet discharges into a spill channel that flows into the Arroyo Hondo arm of Calaveras Reservoir (Figure 2-5). The ACDT outlet has an elevation of approximately 793 feet, which is approximately 37 feet above the maximum normal elevation of the reservoir surface of 756 feet.



**Figure 2-5 Outlet of the Alameda Creek Diversion Tunnel at Calaveras Reservoir**

### 2.3.2.2 ALAMEDA CREEK DIVERSION DAM AND APPURTENANT WORKS

The ACDD is an ogee crest spillway concrete structure. Summary information on ACDD and appurtenances is presented in Table 2-2.

The ACDD has a maximum height of approximately 31 feet (measured from the ogee crest to the downstream apron) with a length of 173 feet, a 92-foot section of which accommodates spilling. The ACDD is bounded by cutoff walls both upstream and downstream and sits on a concrete apron formed into the bed of upper Alameda Creek. The right abutment ties into a sloped retaining wall that continues downstream and terminates at approximately the downstream cutoff wall location. The left abutment consists of a gravity wall. Upstream of the left abutment is an approximately 82-foot-long, multilevel trash rack structure (Figure 2-4). To the south of the trash rack structure is a cliff that forms the left (south) stream bank.

<b>Table 2-2 Description of Alameda Creek Diversion Dam and Appurtenant Works</b>	
Year Completed	December 1931
Location	Alameda Creek, approximately 2.5 miles upstream of the confluence with Calaveras Creek
Catchment Area	21,000 acres
Pool Area	Approximately 1 acre at elevation 904 feet
Key Elevations <sup>1</sup> (NGVD29) <sup>2</sup>	
Dam Crest (top of structure)	919 feet
Ogee Spillway Crest	904 feet
Outlet Tunnel Invert (ACDT)	892 feet
Sluiceway Tunnel 1 (upstream invert)	883 feet
Sluiceway Tunnel 2 (upstream invert)	886 feet
Spillway Capacity	7,500 cfs with 7.5 feet over the spillway (7.5 feet of freeboard) 12,500 cfs with 10 feet over the spillway (5 feet of freeboard)
General Dam Information	
Reinforced Concrete Slab & Buttress	4,500 cubic yards
Maximum Height – Foundation to Ogee Crest	31 feet
Length of Crest	173 feet
Length of Overflow Ogee Crest	92 feet
Notes: <sup>1</sup> Elevations are rounded to the nearest whole number. <sup>2</sup> The historic drawing of the ACDD showing both plan and section views that was used to develop figures in this and other related documents, is drawn referenced to "San Francisco Water Dept. Datum" a.k.a. "Crystal Springs Datum." For consistency with the Calaveras Dam Replacement Project documents and others, elevations were converted to NGVD29 by adding 3.757 feet to Crystal Springs Datum. This conversion is based on SFPUC drawing number B-3448. ACDT = Alameda Creek Diversion Tunnel cfs = cubic feet per second NGVD29 = National Geodetic Vertical Datum 29	

Water is diverted by the ACDD through the trash rack to a side channel (sediment channel). The sediment channel leads to two 5-foot-wide by 7-foot-tall portals. These ACDT portals merge into a single 5.5-foot-by-6.5-foot concrete tunnel that heads south through the mountain for 1.8 miles to Calaveras Reservoir. The trash rack structure is the only screening at the dam and can become full or clogged with debris during high flows. Under normal operation, water from upper Alameda Creek is diverted during winter and early spring months to Calaveras Reservoir via ACDT (from approximately late November through April). In the spring, diversions are generally stopped, and the gates to ACDT are closed.

The ACDD left abutment gravity wall includes two sluice tunnels, or sluiceways. Sluiceway 1 (the upper sluiceway) is used to sluice bedload buildup behind the spillway portion of the ACDD, and Sluiceway 2 (the lower sluiceway) is used to remove bedload from behind the gravity wall within the sediment channel (Figure 2-4). The invert of Sluiceway 2 is approximately 6 feet below the invert of the ACDT portal, allowing room for bedload to settle. The downstream portals of the sluiceways are



almost never submerged; except during extreme high flows, the water surface elevation downstream of the spillway remains below the invert of the lower sluiceway.

During diversion to Calaveras Reservoir, both sluiceways typically remain closed. In general, it is understood that standard procedure is to sluice the sediment channel at least once per year (at the end of the diversion season) or as needed to prevent bedload from being transported into the ACDT. This entails opening one or both of the sluiceways to flush sediment from behind the ACDD and sediment channel.

Access to the dam site is via a maintenance road that approaches from the northwest and dead-ends just east of the right abutment. Access to the left side of the dam in high-flow times is restricted to a gallery (approximately 3 feet wide by 6 feet high) that runs through the dam. During low-flow periods, the left side can be accessed by walking across Alameda Creek upstream of the trash rack, or by walking across the ogee crest spillway when it is not spilling.

Modification of ACDD and its operation are proposed in relation to the SFPUC's Calaveras Dam Replacement Project (CDRP). CDRP includes provision of water releases in accordance with a Memorandum of Understanding (MOU) with the CDFG (CDFG, 1997). The flow compliance point for this instream flow schedule is immediately below the confluence of Calaveras and Alameda creeks. To maximize aquatic habitat under future CDRP operations, SFPUC will provide bypass flows from the ACDD whenever flows are available and will supplement flows with releases from the replacement Calaveras Dam, as needed, to meet the requirements of the MOU (SFPUC, 2008a). The SFPUC has also proposed an instream flow schedule for future populations of steelhead (SFPUC, 2009b). The SFPUC-proposed instream flow schedule would provide differing amounts of flow depending on annual hydrologic conditions (dry, normal, or wet), as summarized in Table 2-3, and illustrated in Figure 2-6. To provide ACDD bypass flows under the CDRP, SFPUC plans to construct a new tunnel through the left abutment of the ACDD, or like structural components, through which flows will be bypassed.

Additionally, as noted in the programmatic environmental impact report (PEIR) for the SFPUC Water System Improvement Program (WSIP), it is anticipated that the SFPUC, when implementing CDRP, will adopt a mitigation measure to provide a bypass of up to 10 cfs downstream of the ACDD from December 1 to April 30 whenever sufficient flow is present in the stream (SFPD, 2008). For the purposes of this technical memorandum, it is assumed that both the SFPUC-proposed instream flow schedule and the WSIP mitigation flows would be provided as bypass flows at ACDD whenever such flows are available.

## 2.4 STEELHEAD PRESENCE IN THE ALAMEDA CREEK WATERSHED

Historic population estimates of steelhead in the Alameda Creek Watershed are unavailable, but steelhead were historically present (Leidy, 2007). Based on various anecdotal accounts of steelhead presence in the watershed from as early as the 1930s, the size of the watershed, the presence of perennial streams, and various *O. mykiss* records from surveys since the 1930s, it is likely that in the past this watershed supported a large steelhead run, relative to other San Francisco Estuary streams (Leidy et al., 2005).

**Table 2-3  
SFPUC Proposed Instream Flow Schedule**

Flow Schedule Decision Date	Flow Schedule Application Period	Wet (Schedule A)		Normal (Schedule B)		Dry (Schedule C)	
		Cumulated Flows for Water Year Classification (MG)	Flow Requirement (cfs)	Cumulated Flows for Water Year Classification (MG)	Flow Requirement (cfs)	Cumulated Flows for Water Year Classification (MG)	Flow Requirement (cfs)
N/A	October	N/A	7	N/A	7	N/A	7
N/A	Nov. – Jan. 11	N/A	5	N/A	5	N/A	5
Jan. 11	Jan. 12 – Jan. 31	> 3,660	42*	1,166 – 3,660	20*	< 1,166	20*
Jan. 31	Feb. 1 – Feb. 28	> 6,882	42	2,597 – 6,882	20	< 2,597	20
Feb. 28	Mar. 1 – Mar 31	> 11,859	42*	5,721 – 11,859	20*	< 5,721	20*
March 31	Apr. 1 – Apr. 30	>17,449	32 – 18*	6,563 – 17,449	15*	< 6,563	7*
April 30	May 1 – May 31	> 18,211	15	7,246 – 18,211	15	< 7,246	7
May 31	June 1 – June 30	> 18,551	15	7,838 – 18,551	15	< 7,838	7
June 30	July 1 – Sept. 30	> 18,693	15	7,948 – 18,693	15	< 7,948	7

Notes:  
 The new flow schedule would be implemented after passage at the BART weir has been provided and NMFS has confirmed steelhead occurrence upstream of the BART weir through a letter to SFPUC.  
 \* Daily ramping schedule applies  
 cfs = cubic feet per second  
 MG = million gallons

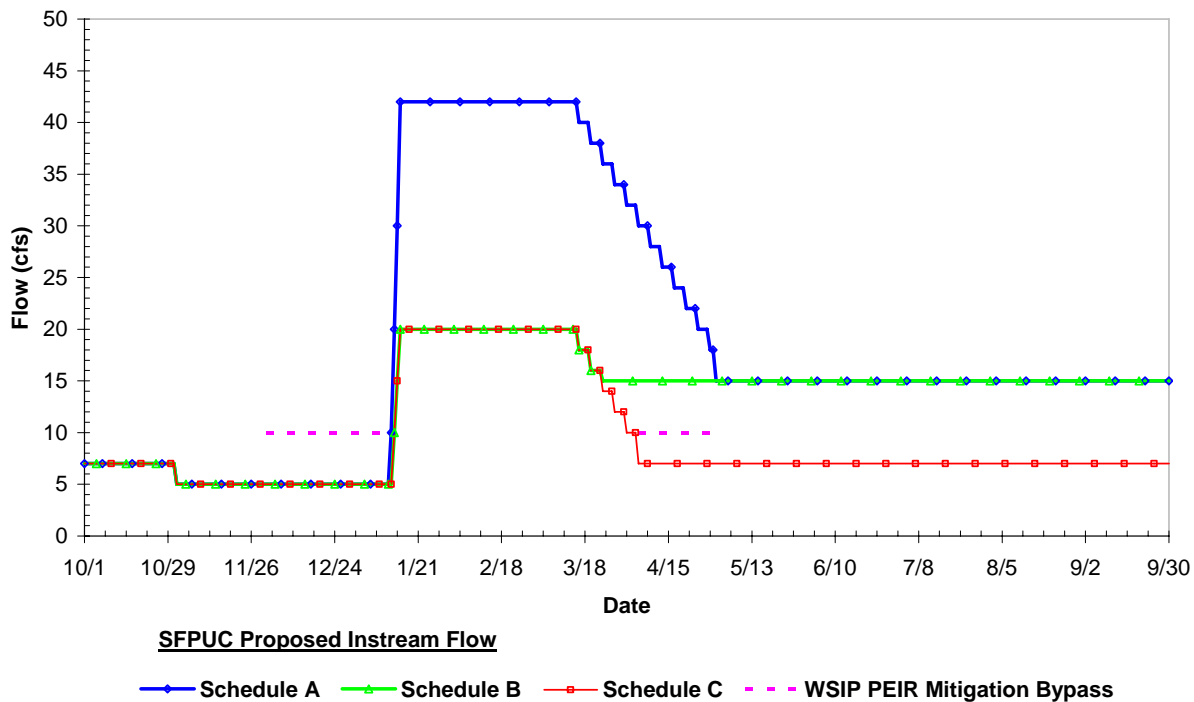

**Figure 2-6 SFPUC Proposed Instream Flow Schedule and WSIP Program Mitigation Measure Flow**

Rainbow trout are the same species as steelhead, but rainbow trout spend their entire life-cycle in fresh water, while steelhead have an anadromous life history. Rainbow trout are currently present in the Alameda Creek Watershed, including in areas above and below the ACDD (SFPUC, 2004). There are well-documented reports of steelhead in the lower Alameda Creek channel below the BART weir (approximately 10 miles upstream of San Francisco Bay and approximately 18 miles downstream of ACDD; Figure 1-1). This weir currently presents an impassable upstream migration barrier<sup>4</sup> (Gunther et al., 2000; Hayes, 2001). Small numbers of adult steelhead have been observed attempting to pass the BART weir (Gunther et al., 2000), some of which have been relocated above the weir and subsequently tracked to Stonybrook Creek (approximately 13 miles upstream of San Francisco Bay and approximately 15 miles downstream of ACDD), where they were observed spawning (San Jose Mercury News, 2008). Additional structures and natural cascades upstream of the BART weir also present obstacles for upstream movement of fishes (Gunther et al., 2000).

A number of existing facilities under the jurisdiction of Alameda County Water District (ACWD), ACFCWCD, California Department of Water Resources, SFPUC, and Zone 7 Water Agency, among others, strongly affect hydrological and fisheries habitat conditions in the Alameda Creek Watershed downstream of ACDD. Many of these structures and facilities have been in existence for well over 80 years, and have resulted in substantial changes to the natural conditions that existed before the twentieth century when a steelhead run is presumed to have been present throughout the basin. Although built in the past, these existing facilities and influences continue to operate and affect habitat conditions for steelhead in the Alameda Creek Watershed. Some of these are direct barriers to fish migration; others pose various degrees of control/influence over habitat conditions (Gunther et al., 2000). The major facilities are listed below by sub-watershed.

In the Arroyo de la Laguna Sub-Watershed:

- Del Valle Dam and Reservoir/South Bay Aqueduct, including State Water Project releases;
- Quarry lakes recharge facilities;
- Various channelized and culverted stream segments; and
- Expanding urban development of the Tri-Valley Area.

In the Upper Alameda Creek Sub-Watershed:

- Calaveras Reservoir and Dam;
- Alameda Creek Diversion Dam and Tunnel;
- Sunol Valley aggregate mining operations and quarries;
- Turner Dam and San Antonio Reservoir;
- Sunol Valley infiltration galleries; and
- Pacific Gas and Electric Company (PG&E) pipeline crossing protection covering (drop structure).

In the Lower Alameda Creek Sub-Watershed:

- ACWD's upper, middle, and lower inflatable dams and quarry pit recharge facilities;
- BART weir; and
- ACFCWCD channelization project.

<sup>4</sup> Although the BART weir is typically considered to be the impassable barrier that is the farthest downstream in the watershed, a large inflatable dam, used for water division by the Alameda County Water District, is downstream of the BART weir. Plans have been provided to have this rubber dam removed and foundation notched in 2009 (CEMAR, 2009).

All of these facilities, combined with urbanization and other land use activities, have resulted in substantial alteration of habitat conditions for steelhead in the watershed.

Nielson (2003) examined mitochondrial DNA and 14 microsatellite loci of rainbow trout from Alameda Creek and found that trout from Arroyo Hondo, upper Alameda Creek, and San Antonio Reservoir are more closely related to steelhead captured in Alameda Creek below the BART weir than they are to any other wild or hatchery population of *O. mykiss* examined in the study. These trout were also found to be similar to populations from other creeks within the Central California Coast (CCC) steelhead Distinct Population Segment (DPS). A more recent analysis of the genetic diversity and population structure of *O. mykiss* in nearby streams of the Santa Clara Valley examined 18 microsatellite loci and found that populations of trout from above dams in the Guadalupe, Pajaro, and Permanente/Stevens basins are all of recent steelhead ancestry (Garza and Pearse, 2008). Future genetic studies would be necessary if it was determined that information was needed on the precise evolutionary origin of steelhead attempting to immigrate into the Alameda Creek Watershed.

On January 5, 2006, the CCC DPS, including all populations of naturally spawned anadromous steelhead (*O. mykiss*) below natural and manmade impassable barriers, were listed as threatened under the federal Endangered Species Act by the Department of Commerce, National Oceanic and Atmospheric Administration, National Marine Fisheries Service (NMFS, 2006). The geographic extent of this DPS (inset box, Figure 1-1) includes coastal drainages from Soquel Creek in Santa Cruz County (inclusive), north to the Russian River in Sonoma County (inclusive), and the drainages of San Francisco, San Pablo, and Suisun Bays east of Chipps Island at the confluence of the Sacramento and San Joaquin river systems. Steelhead that spawn in the Sacramento-San Joaquin River Basin are within a separate DPS. In the Final Listing Determination, NMFS (2006) concluded that the resident rainbow trout population in Alameda Creek is not considered part of the CCC DPS, in part due to their reproductive isolation resulting from manmade barriers. When steelhead (CCC DPS) are successfully re-established in the Alameda Creek Watershed via the removal or modification of passage barriers, all rainbow trout (*O. mykiss*) in areas made accessible from the ocean will be considered part of the same population regardless of their realized life history character (i.e., anadromous, fluvial, or adfluvial).

The historic steelhead population of the Alameda Creek Watershed can be referred to as a metapopulation. NMFS (2005) defines metapopulations as “spatially structured populations in which populations or subpopulations occupy habitat patches, connected by some low-to-moderate stray rates.” Low-to-moderate levels of straying result in regular genetic exchange among subpopulations, creating genetic similarities among populations in adjacent watersheds or sub-watersheds. Because the historic Alameda Creek Watershed population may have been functionally independent of populations in other watersheds (Spence et al., 2009), it is probably most appropriate to think of the entire watershed as the metapopulation, and the subpopulations as occupying the sub-watersheds or basins with the Alameda Creek Watershed (Table 2-1). Metapopulation theory and the ecology of steelhead suggest that management efforts that increase the rate of colonization of currently unoccupied habitats may promote the recovery and persistence of Pacific salmon stocks, including steelhead (Young, 1999).

Efforts are currently underway to restore the migration of adult steelhead into the Alameda Creek Watershed. The Alameda Creek Fisheries Restoration Workgroup (ACFRW) was established in 1999 (CEMAR, 2002). The workgroup has generated a report which assesses the potential for a viable steelhead population to exist in Alameda Creek (i.e., Gunther et al., 2000). Efforts to restore steelhead populations to Alameda Creek have targeted the elimination of fish migration barriers, particularly those in the lower reaches (Gunther et al., 2000; Wood Rogers, 2007).

A number of future projects could potentially affect conditions for steelhead in the Upper and Lower Alameda Creek sub-watersheds, and affect the ability of steelhead to immigrate to ACDD. Several of these projects are in various stages of planning and implementation by public agencies, citizens' groups, and quarry operators. They include removing/modifying dams, weirs, culverts, and pipelines that block fish passage, installation of positive barrier fish screens at water diversions, restoring and protecting habitat, and providing instream flows.

Of particular importance to this analysis is the existence of several fish migration barriers in the watershed and associated future projects to address passage. These obstructions include the BART weir; ACWD rubber dams (ranging in location from about 2 miles upstream of the Bay to just below Niles Canyon); and the PG&E concrete drop structure in the Sunol Valley. Two structures on Alameda Creek in the Niles Canyon—the Niles and Sunol dams—were removed by the SFPUC in 2006. The East Bay Regional Parks District (EBRPD) has also removed two small barriers from Sunol Wilderness Regional Preserve. ACWD intends to remove its lowermost rubber dam during 2009 (CEMAR, 2009), and construction of a fish ladder at the BART weir and a second rubber dam is anticipated for 2010. Other migration barriers along the creek are in various stages of planning to address passage. It is assumed that these projects will be completed at some point in the future, and steelhead will have access to the Upper Alameda Creek Sub-Watershed, where ACDD is located.

## 2.5 OTHER FISH SPECIES IN THE STUDY AREA

A review of aquatic surveys conducted in the Alameda Creek Watershed found that stream surveys in Upper Alameda Creek Basin are limited to those that have been conducted by the U.S. Environmental Protection Agency during the 1990s and later by SFPUC (Entrix, 2003). While this technical memorandum is focused on steelhead, several other fish species are present in the study area, including prickly sculpin (*Cottus asper*), California roach (*Hesperoleucus symmetricus*), Pacific lamprey (*Lampetra tridentata*), Sacramento sucker (*Catostomus occidentalis*), Sacramento pikeminnow (*Ptychocheilus grandis*), and largemouth bass (*Micropterus salmoides*). In addition to steelhead, volitional passage could potentially benefit anadromous lamprey. Resident stream fishes might also benefit from volitional passage, which could have positive effects on their population genetic fitness (Campbell et al., 1999) and ability to recolonize areas from which they have been extirpated (Begon et al., 1996). Screening at the ACDT, which would be required in conjunction with passage, could prevent resident fishes from being entrained in the ACDT and transported to Calaveras Reservoir.

The biological benefits and technical requirements associated with providing passage for non-salmonid fishes, however, are not as well understood as for anadromous steelhead and salmon. Provision of volitional passage for steelhead via a device such as a fish ladder may be more likely to benefit other species than non-volitional passage, such as trap and haul, but it is unknown to what degree passage designed to benefit steelhead could simultaneously accommodate other species, due to differences in life history, habitat requirements, size, and swimming ability. Due to the difficulty and expense associated with passage, it is unlikely to be implemented for species without a compelling need to regularly pass the dam. Although Chinook salmon (*Oncorhynchus tshawytscha*) have been observed in Alameda Creek below the BART weir (Leidy, 2007), it is uncertain whether they are native to the Alameda Creek Watershed. Chinook salmon spawning runs in nearby Guadalupe River and Coyote Creek are of hatchery origin (Moyle, 2002; Leidy, 2007), and the origin of this species in many San Francisco Bay tributaries may never be conclusively demonstrated (Leidy, 2007). For these reasons, this technical memorandum addresses the feasibility and benefit of providing passage at ACDD for steelhead only.



---

## 3 METHODOLOGY

### 3.1 BACKGROUND INFORMATION REVIEW

This evaluation is based on a review of devices and methods used at other dams that currently have fish passage operations in place, in combination with aerial photographs, site visits, and input from knowledgeable experts. Literature was also reviewed on fish physiological responses to handling, behavioral responses to devices, steelhead reproductive success, steelhead life history characteristics, and general fish passage concepts. Whenever possible, information specific to steelhead was used in the evaluation. In the absence of available steelhead data, other anadromous salmonid data were used as a surrogate. References are included in the text describing specific devices and methods, and a complete list of references is provided in Section 10.

### 3.2 IDENTIFICATION AND ANALYSIS OF DESIGN COMPONENTS FOR FISH PASSAGE

Identification and analysis of design components consisted of four steps:

1. Identification of fish passage design components that are technologically feasible at ACDD and that would meet the basic biological needs of a steelhead population above ACDD, and elimination of design components that are not considered feasible due to substantial engineering or cost constraints, or that would not meet the biological needs of steelhead at ACDD (Section 4);
2. Estimation of the capital and operating and maintenance (including water) cost of each viable component (Section 5);
3. Estimation of the quantity and quality of habitat that the remaining design components would make available to steelhead (Section 6.1), the ability for passage to sustain a minimum viable population size (Section 6.2), and environmental considerations related to the implementation of fish passage (Section 6.3);
4. Selection of design components most suitable for providing fish passage at ACDD based on the above considerations (Section 6.4).

Each of these four steps is described in more detail below.

The first step used to assess the feasibility of providing fish passage at ACDD was to identify fish passage design components that are technologically feasible at ACDD and that would meet the biological needs of a re-established steelhead population above ACDD. There are three elements to steelhead migration: adult immigration, juvenile emigration, and post-spawn adult emigration. Infrastructure components and operational requirements associated with each potential method of fish passage are identified. These design components are evaluated for their ability to meet the biological needs of steelhead migration, and are simultaneously evaluated for feasibility. Based on these considerations, a determination was made as to whether each design component should be retained for further consideration in subsequent analyses or rejected. Where multiple variations of design components were identified as potentially suitable for use at ACDD, an effort was made to select the design component that appeared most favorable, and only that design component was carried forward.

The design components carried forward through the initial screening were next evaluated based on their relative cost (Section 5). Order-of-magnitude capital, operations, and maintenance costs were developed, including the water cost associated with operating the design components and the lost water diversion opportunity cost associated with screening.

The next step in the analysis was to estimate the amount of habitat that the remaining design components would make available to steelhead. Considering the quantity and quality of habitat available, the potential for passage to sustain a minimum viable population size was evaluated. Non-steelhead environmental considerations related to the implementation of fish passage are also discussed, although these considerations are deferred to a later stage of planning when an impact determination would be more appropriate, and do not weigh heavily on the feasibility evaluation.

The last step in this first stage of the feasibility evaluation was to evaluate the remaining design components in light of all the above considerations, and select the design components most suitable for providing fish passage at ACDD. As a result, two potential fish passage options for ACDD were evaluated for their potential to meet specific fish passage goals, as described below.

### 3.3 EVALUATION OF THE BIOLOGICAL BENEFIT OF TWO PASSAGE OPTIONS

While providing fish passage is almost always “technologically” feasible (that is, it is almost always possible to catch some fish and relocate them somewhere else), simply moving the fish does not accomplish the goals of fish passage. For the purposes of this analysis, the following goals have been identified for fish passage:

- To provide access to additional quantity of habitat to increase natural production;
- To contribute to species recovery through increased overall natural production;
- To provide access to historical habitat;
- To protect or enhance the genetic integrity and/or distinctness of stocks; and
- To reduce risk of extinction through increased natural production and creation of additional independent populations.

The final step in this feasibility evaluation was to examine the potential fish passage options at ACDD, and evaluate their ability or likelihood to meet these goals (Section 7). Following these primarily qualitative evaluations, the potential for success of steelhead passage at ACDD was determined.



## 4 DESIGN COMPONENTS AND PRELIMINARY ANALYSIS

This section describes and evaluates design components that could potentially be used to provide steelhead passage at ACDD based on literature review and experience with existing fish passage projects. In conjunction with passage at ACDD, screening of the ACDT would also be required to protect steelhead present at the diversion. Passage components are described and evaluated in Sections 4.1 through 4.3; screening design components are described and evaluated in Section 4.4.

Steelhead migration consists of the following three primary elements:

- adult immigration;
- juvenile emigration;
- post-spawn adult emigration.

Table 4-1 summarizes the steelhead life-stage time periods when each primary migration element occurs. The time periods presented in the table are based upon the literature review, survey data collected in the Upper Alameda Creek Sub-Watershed, and personal communications with individuals familiar with the watershed.

Passage Element	Month												
	Oct	Nov	Dec	Jan	Feb	Mar	Apr	May	Jun	Jul	Aug	Sep	
Adult Immigration <sup>a</sup>													
Juvenile Emigration <sup>b</sup>													
Post-spawn Adult Emigration <sup>c</sup>													

Sources:  
<sup>a</sup> Gunther et al., 2000; Moyle, 2002  
<sup>b</sup> Gunther et al., 2000; Brian Sak, pers. comm., 2009a; SFPUC, 2004  
<sup>c</sup> Gunther et al., 2000

Adult steelhead immigration in the Alameda Creek Watershed is expected to occur from December through April, with the majority of immigration occurring between December and March (Gunther et al., 2000). Juvenile steelhead emigration naturally occurs simultaneously with the smoltification process when physiological changes occur that adapt the juvenile fish to life in the ocean. In the Alameda Creek Watershed, emigrating steelhead smolts are expected to migrate downstream between March and June, with older fish (ages 2 and 3 years) generally migrating earlier (March and April) and younger fish (age 1 year) migrating later (May and June) (Gunther et al., 2000). Juvenile steelhead may sometimes make small movements related to habitat choice (Kahler et al., 2001), and upstream movements from spawning grounds into suitable summer rearing habitats may sometimes occur (habitat in the study area is described in Section 6.1). Although most steelhead die after spawning, a significant number do not. As much as 20 to 30 percent of an annual steelhead run may be composed of repeat spawners (Shapovalov, 1953; Shapovalov and Taft, 1954). Steelhead that survive spawning typically emigrate to the ocean before returning to spawn again. Migrations are typically expected to occur as described here, but are ultimately dependent upon the rainfall pattern in a given year, which determines when flows suitable for migration are available. A flow duration analysis and a storm peaking analysis would be recommended if further passage design for ACDD is requested; storm peaking analysis would further

define the flows under which steelhead are most likely to migrate. Key design requirements for any passage or screening features would come directly from this analysis.

Design components identified that could potentially facilitate adult immigration to spawning habitats above ACDD include:

- Fish ladders
- Fish lifts
- Trap and haul

Design components to facilitate upstream steelhead migration would be operational from December through April (Table 4-1) (information regarding expected numbers of immigrating steelhead can be found in Section 6.2).

Passage would also require screening at the ACDT, to prevent entrainment of fish into the diversion tunnel, and Calaveras Reservoir. Screening in accordance with regulatory criteria would require a fish screen bypass, which would need to be designed in a manner that could safely provide downstream fish passage at ACDD for both emigrating juvenile and post-spawn adults. Details on future bypass flows at ACDD are presented in Section 2.3.2.2. Bypass flows related to future operation of CDRP would be provided at ACDD via a new outlet structure proposed as part of the CDRP. However, in the analysis in this memorandum it is assumed that SFPUC-proposed instream flows could also be provided by a combination of a fish ladder (Section 4.1), and/or a fish screen bypass flow conduit operated in conjunction with screening of ACDT (Section 4.4). If upstream passage was provided for immigrating adult steelhead, fish screen bypass flows would be the associated primary mechanism allowing emigrating steelhead to bypass the dam in a downstream direction.

This section describes the adult immigration and fish screen design components and provides a preliminary evaluation of their suitability at ACDD. Design components that are technically feasible at ACDD and that would meet the basic biological needs of a steelhead population above ACDD are retained for further evaluation. Design components are eliminated from further consideration in this memorandum if they serve the same purpose as other design components but at a clearly higher cost, with greater engineering challenges, or are otherwise determined to be less suitable than substitutable designs.

## 4.1 FISH LADDERS

In this section, fish ladders (sometimes more generally referred to as fishways) are evaluated as a specific design component for providing passage to immigrating adult steelhead. Following the analysis, this design component is retained for consideration later in this document.

A fish ladder is a structure used to facilitate passage of fish over or around an obstacle, typically a dam or other migration barrier (Figure 4-1). Specifically, as defined by NMFS, the fish ladder is the component of a fish passage facility that dissipates hydraulic potential energy into discrete pools or into a baffled chute to provide passage for upstream migrants (NMFS, 2003). Fish ladders are the method most commonly used for allowing upstream fish migration past instream barriers. Although design criteria for fish ladders are primarily based on adult fish immigration, when operating, some fish ladders also can provide for downstream migration.

Typically, fish ladders consist of a series of ascending pools that must be “climbed” or jumped by the fish. A series of pools contained within the water passage acts to incrementally divide the height of the passage and to dissipate the energy in the water, thereby enabling fish to gradually climb the



(a) Vertical slot Potter Valley fish ladder on the Eel River in California.



(b) Fish passage facility at Redlands Diversion Dam on Gunnison River, Colorado.



(c) Hybrid vertical slot/pool-and-weir fish ladder on El Jaro Creek, CA.

**Example Fish Ladder Photos**

Feasibility of Fish Passage at Alameda Creek Diversion Dam  
Technical Memorandum

June 2009

Figure 4-1

height required to pass over the obstacle. The number of pools contained within the fish ladder depends on the climb required to pass over the obstacle. Although the incremental drop between pools may vary depending on the leaping capabilities of the species that need to pass through the ladder, a drop of 1 foot is most commonly used for anadromous salmonid species. Fish move up the ladder by leaping from one pool to the next in an upstream direction. After ascending the ladder, individuals can be collected in confined pools or tanks at the top of the ladder or allowed to proceed directly into the body of water above the obstacle (Larinier, 2000; USACE, 1996).

There are a variety of fish ladder designs; all have the same basic concept. The three most common fish ladders are pool and weir, vertical slot, and weir and orifice. The height and length of individual ladders varies depending upon the height of the obstacle, the hydrology of the river system, and the fish species using the facility. Due to the large number and wide variety of fish ladders currently in use, a substantial body of technical information is available that describes the species-specific and physical requirements of fish ladders.

In general, fishways require a narrow range of depth fluctuations in the forebay (the water behind a dam) to operate successfully, typically less than 10 feet. The variation in forebay versus tailwater elevations is an important design element and limits success of various types of fishways. The greater the fluctuation observed, the more difficult it is to provide upstream passage successfully over the range of anticipated migration flows without a series of added appurtenances. Attraction flow and water temperatures also play an important role in attracting fish to the entrance of a fishway. Control of water temperatures in a fishway is also a critical design issue.

## **USE OF FISH LADDERS**

A review of the fisheries literature and consultation with fish passage experts was conducted to locate examples of successful fish ladder installations with environmental and topographical features similar to those at the ACDD.

Fish ladders are a proven technology to allow volitional upstream fish passage at migration barriers for anadromous and non-anadromous fish species. Properly constructed and well-placed fish ladders have high efficiency rates, even at relatively large fish ladders. (Efficiency rate is typically defined as the percentage of fish detected below the dam and then again above the dam.) Studies investigating salmonid passage at six relatively large fish ladders report passage efficiencies of from 88 to 95 percent (Burke et al., 2001). Ferguson et al. (2002) suggest that upstream fish passage facilities should allow for greater than 95 percent efficiency.

Much of the historic use of fish ladders has been either at run-of-the-river hydropower and diversion dams, or at dams below reservoirs, where the ladder leads to a holding pool at a fish hatchery. Many of these facilities have been built on large rivers with perennial flow. While these applications are similar in some ways to a potential fish ladder at ACDD, several site-specific factors, including the lack of perennial flows or water storage, the flashy nature of the seasonal flows, and the fluctuating forebay conditions, present challenges for fish passage not encountered at run-of-the-river dams, or at hatchery ladders that terminate at a holding pool.

For example, in California and elsewhere, several existing fish ladder installations of a height similar to what would be needed at ACDD provide volitional upstream fish passage. The Nimbus Fish Hatchery on the American River in California has a pool-and-weir-type fish ladder ascending approximately 25 feet to a holding pool, from which adult steelhead are collected and artificially spawned. A vertical slot ladder at the Potter Valley Project on the Eel River in California allows for the upstream passage of adult Pacific salmon and steelhead (Figure 4-1a). A hybrid vertical-slot-and-

orifice-type fish ladder was constructed at the Redlands Diversion Dam on the Gunnison River near Grand Junction, Colorado (Figure 4-1b). The ladder was constructed to facilitate upstream adult fish passage for the federally listed Colorado pikeminnow and the razorback sucker and has been in operation since 1996 (McAda and Burdick, 2007). The fishway was designed with removable vertical-slot-and-orifice-type fish passage baffles to allow for a consistent flow pattern over a range of about 10 feet of headwater and tailwater elevations. The ladder is approximately 350 feet in length and ascends a height of approximately 35 feet with flows through the passage ranging from 11 to 17 cfs (U.S. Department of Interior, 1995). While all of these ladders are similar in height to what could be constructed at ACDD, they are all on much larger rivers, and the operation of these ladders and the dams they bypass is different from what could be implemented at ACDD.

In California, there are examples of fish ladders that have been built on streams without perennial flow. In 1921 (Becker and Reining, 2008) a pool-and-weir fish ladder was built to provide upstream passage for steelhead at the 107-foot-tall San Clemente Dam on the Carmel River, the tallest fish ladder in the state (Carmel River Watershed Conservancy, 2005). The Carmel River Watershed is approximately 163,000 acres (Becker and Reining, 2008), and is similar in size to the Upper Alameda Creek Sub-Watershed (Table 2-1). Below Los Padres Reservoir (approximately 6 miles upstream of San Clemente Dam), low flows are regulated, but the channel below San Clemente Dam is intermittent in some years (USGS, 2008). Recent concerns regarding the structural integrity of San Clemente Dam during seismic events have forced a reduction in the reservoir operating forebay elevations, which has decreased the ladder's effectiveness. Additionally, the ladder does not currently meet CDFG and NMFS guidelines (Smith et al., 2004), and is scheduled for replacement.

More recently, construction of the San Julian Ranch Fishway on El Jaro Creek, near Lompoc, California, was completed during the summer of 2008. This fish ladder was designed and constructed to provide upstream volitional passage for adult and juvenile steelhead trout over a 9-foot-tall diversion dam (HDR, 2008). El Jaro Creek is an intermittent stream with a watershed of approximately 21,000 acres, with expected maximum daily average flows during peak storm events of approximately 4,000 cfs (HDR, 2007). The ladder on El Jaro Creek was configured as a hybrid vertical-slot-and-pool-and-weir-type structure to facilitate passable hydraulic conditions over a large range of stream flows (HDR, 2008). During the winter months when the potential for large "flashy" stream flows exists, the fish ladder is configured as a vertical-slot type ladder with operation flows of 5 to 20 cfs targeting immigrating adult steelhead (Figure 4-1c). In this configuration, each pool has a maximum hydraulic differential of 0.8 foot. During the summer months, the ladder is converted to a pool-and-weir type system by moving a series of stoplogs and inserting weir panels. During this summer period, stream flows ranging from 0.5 to 5 cfs are routed through the fish ladder targeting juvenile steelhead that are searching for more hospitable over-summering habitat that exists in the upper watershed. The maximum pool-to-pool hydraulic differential is 0.5 foot when in this configuration. Monitoring efforts are being performed by the Cachuma Conservation Release Board to evaluate the overall effectiveness of the fishway.

## **USE OF A FISH LADDER AT ACDD**

Ideally, the fish screen bypass (see Section 4.4) and fish ladder at ACDD would be combined into a single structure, thereby minimizing the volume of water required to operate the passage components and reducing the construction footprint, while simultaneously providing fish passage over ACDD and protection at screens. However, the left side of ACDD (where a fish screen bypass would be required) is built up against a steep rock cliff. Due to these space constraints, construction of a fish ladder on the left side of ACDD appears very challenging, and may not be feasible. Therefore, separate flows would likely be required to operate a fish ladder on the right side of ACDD and to provide fish bypass flows at the screens on the left side of the ACDD.

A vertical slot, weir, and orifice, or a hybrid type of fish ladder could be feasible on the right side of ACDD. The fish ladder would likely involve an initial vertical slot configuration at its upper end due to the variation of forebay elevations during operational and fish migration periods. Two potential fishway paths were considered during the analysis of fish ladders at ACDD. In either case, the fishway would extend from below the bottom of the existing concrete apron to a location above ACDD (Figure 4-2).

In general, the fishway entrance is most successful when located near the downstream face of a barrier. At this location, it may be most effective to provide a barrier at the downstream edge of the existing concrete apron approximately 100 feet downstream of the spill crest. At this location, a physical drop structure or velocity barrier could be constructed to inhibit passage farther upstream. With appropriate attraction flow to the fishway and a barrier to movement towards the face of ACDD, fish migrating upstream would have greater success finding and entering the fishway.

Due to the wide range of unimpaired flows in Alameda Creek, the upper end of either fishway would require incorporation of a control structure to regulate the flow of water into the ladder. The control structure may require multiple fish exits (water entrances) to accommodate the various water surface elevations that would be expected to occur at the top of the fishway. The control structure would likely incorporate vertical slots with a width of 1 to 1.5 feet.

Since flows and channel conditions are uncontrolled upstream of ACDD, a large amount of debris and bedload is flushed downstream, which accumulates in the area around ACDD. It would therefore be necessary to implement a maintenance program to ensure that the fish ladder remained operable.

Two potential fishway paths have been evaluated: a Short Fishway and a Long Fishway (Figure 4-2). A Short Fishway would involve construction of a fishway around ACDD on the right bank. The fishway exit would be just upstream of the ogee crest spillway structure. This fishway would likely be a vertical slot design, or a hybrid vertical slot with weir and orifice at the lower end. If the uppermost pool in the fish ladder (fish exit) was configured near the spillway, the structure walls would be in the range of 10 to 20 feet high depending on the relative operational diversions and corresponding variation of forebay elevations. Based on the elevation of the ACDD ogee crest spillway and the invert of the ACDT (Table 2-2), when the creek is flowing the forebay elevation is expected to fluctuate a minimum of 12 feet, prior to spilling over the crest. The flow range of the fishway is dictated by the hydraulic control at the water entrance. A control structure with multiple fish exits would allow the fish ladder to function over a range of forebay elevations. Water flow into the fishway is proportional to water surface height. In most cases, 5 cfs or more would be required for operation of a vertical slot fishway. It is estimated that operational flows in the fishway would range from 10 to 40 cfs<sup>5</sup> when stream flow is greater than 5 to 10 cfs. It may be possible to operate a pool and weir fishway at lower flows.

A Long Fishway would also involve construction of a fishway around ACDD on the right bank, but the fishway exit would be located farther upstream, above the hydraulic influence of the ACDD forebay. This ladder would likely be a hybrid type consisting of a vertical slot and possibly weir and orifice for the lower portion, and a roughened channel for the upper section. If the upstream pool was configured above the forebay, the variance in hydraulic water surface elevations during anticipated fish migration flows would dictate structure height, in this case assumed to range between 8 and 12 feet. The flow range of a Long Fishway would also be dictated by the hydraulic control at the water entrance, and water flow into the fishway is proportional to water surface height. In this case,

---

<sup>5</sup> No flow duration analysis or a storm peaking analysis has been performed as part of the estimate of fish ladder operational flows. These analyses, combined with ladder design work and coordination with NMFS and CDFG, would be used to determine the actual operational flows through a fish ladder at ACDD.



the variation in water surface elevation at the water entrance would be limited to the natural water surface elevations. It is assumed that this fluctuation would be less than what is observed at the dam, and therefore it would be possible to design a fishway that operates with less flow. It is estimated that this configuration would operate with flows ranging from 5 to 30 cfs<sup>5</sup>, when stream flow is greater than 5 cfs.

An upstream exit located above the hydraulic influence of the forebay, as in the Long Fishway, would require an independent impound, such as a weir across the stream to divert water into the fishway. An upstream impound could potentially be designed to feed a more refined range of flows into the fishway, compared to a deep slot near the spillway. It may be possible to exercise greater control over the amount of water bypassed through the Long Fishway than through the Short Fishway. Greater control of the amount of water bypassed through the fishway could help control the annual water cost of operation.

The hydraulic differential between each pool is anticipated to range between 0.5 and 0.8 foot, which would meet requirements for upstream juvenile and upstream adult passage (NMFS, 2008a), respectively. Each pool would likely have a width varying from 6 to 8 feet and a length varying from 8 to 10 feet.

Using these basic concepts and the approximate height differential between the spillway and the downstream edge of the concrete apron, an approximation of fishway length can be derived. If the spillway crest is at elevation 904 feet and the downstream edge of the concrete apron is approximately 867 feet, the total height differential is 37 feet. With an assumed height differential between pools of 0.8 foot, and incorporating several required resting pools, the length of the Short Fishway would be approximately 400 feet. An additional 400 feet of fishway may be required to extend the facility upstream of the hydraulic influence of the forebay, as for the Long Fishway shown in Figure 4-2.

While either fishway may be feasible at ACDD, for the purposes of this analysis a preliminary assessment of the relative suitability of a Short and Long Fishway is addressed, and only one fishway is carried forward for further analysis in this memorandum. The primary advantages of a Short Fishway are the reduced physical area of impacts and lower construction costs that would be associated with a shorter structure. However, a Long Fishway would involve construction of an impoundment designed specifically for feeding flow into a fish ladder. Therefore, it may be possible to exercise greater control over the amount of water that passes down the fishway. Although it may cost more to build, the Long Fishway may be more cost effective for SFPUC because it may require less water to operate effectively. Additionally, a Long Fishway would have less impact on the existing ACDD structure. While a Short Fishway may also be feasible at ACDD, the Long Fishway is the concept carried forward for further analysis because as water costs rise over time, the water cost associated with operating a fish ladder is expected to outweigh the capital cost of its construction.

An advantage of fish ladders compared to other fish passage methods is the minimal handling and associated stress to the fish. The suitability of a fish ladder at ACDD depends on the ability of fish to immigrate past Little Yosemite, or provision of passage at that barrier. Based on its ability to achieve volitional passage for immigrating steelhead at ACDD and its successful use at many other facilities, the fish ladder design component is retained for further consideration in this memorandum.

A ladder at ACDD would be operated December through April, whenever flows sufficient for its operation are present in the creek, as needed to accommodate adult immigration. In providing sufficient flows to operate both a fish ladder and separate fish screen bypass (see Section 4.4), flows in excess of the SFPUC-proposed instream flow schedule flows would sometimes be necessary. The



potential cost, including water cost, that may be associated with the implementation of a Long Fishway is discussed in Section 5.

## 4.2 FISH LIFTS

A review of available literature and existing projects indicates that three basic types of mechanical lifts are typically used for fish passage: navigation locks, fish locks, and fish elevators (collectively referred to below as “fish lifts”). A navigation lock (see photograph [a] on Figure 4-3) is mainly used to raise and lower boats between stretches of water at different elevations. A fish lock (see photograph [b] on Figure 4-3) consists of holding chambers at the upstream and downstream sides of a dam linked by a sloping or vertical shaft that is filled with water when immigrating fish enter the downstream chamber. The efficiency of such a fish facility depends mainly on the behavior of the fish, which must remain in the downstream pool during the whole of the attraction phase, follow the rising water during the filling stage, and leave the lock before it empties. A fish elevator (see photograph [c] on Figure 4-3) works by luring fish with rushing water to a compartment at the base of the dam. The fish swim into the compartment and are unable to find their way out. The compartment is then lifted like an elevator until it reaches a holding pen or flume, where the fish are released into a reservoir or river above the dam.

Mechanical fish lifts are not well suited for passage at ACDD. All three types of fish lifts described above require substantial inputs of electrical power to operate, and no grid electrical power is available at or within approximately 3 miles of ACDD. Even if power was brought to ACDD, Larinier (2007) reports that fish lifts suffer the following disadvantages compared to ladders: higher operating and maintenance costs, more chance of breaking down, and a higher risk of damage to fish. For these reasons, mechanical fish lifts are eliminated from further consideration in this technical memorandum.

## 4.3 TRAP AND HAUL

While resource agencies more commonly propose volitional passage for upstream passage facilities, as opposed to trap and haul, there are sites where trap and haul is appropriate (NMFS, 2008a). Because Little Yosemite, located between ACDD and the Alameda Creek confluence with Calaveras Creek, has been identified as a potential impediment to immigrating steelhead (see Section 2.3), passage at ACDD may warrant consideration of trap and haul.

Information on the capture and transportation of immigrating adult steelhead is presented in this section. First, either a facility for collecting immigrating adults would need to be constructed or some sort of manual trapping (e.g., fish traps or nets) would be required. Second, a method would be required to transport the captured fish to a location upstream of ACDD. Downstream passage for emigrating steelhead would be provided by the bypassing of flow necessary for fish screen operation (Section 4.4).

Therefore, the trap and haul program would not require trapping and transporting juveniles or post-spawn adults.

### **COLLECTION OF IMMIGRATING ADULT FISH (TRAP)**

This design component would need to capture upstream migrating adult steelhead while minimizing mortality due to stress associated with handling and transport. Collection of adult immigrating steelhead would involve construction of a small fish ladder or weir leading to a holding pool of sufficient size to accommodate a significant number of adult steelhead prior to transporting the adults to an upstream location.



(a) A view of the navigation lock at the Beaucaire power plant on the Rhone River in France.

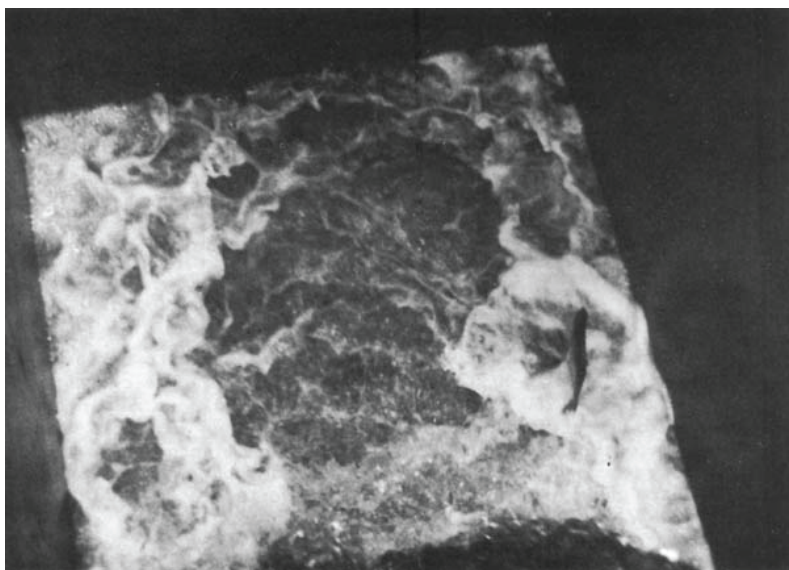

(b) A photograph of a Borland type fish lock filling and fish leaping out of water at Salto Grande hydroelectric plant in Argentina.



(c) A view of the fish elevator on the Connecticut River in Holyoke, Massachusetts.

### Example Fish Lift Photos

Feasibility of Fish Passage at Alameda Creek Diversion Dam  
Technical Memorandum

June 2009

Figure 4-3

NMFS (2008) describes criteria for holding pools and fish trapping systems. The NMFS handling guidelines indicate specific requirements for holding pool conditions, including a minimum holding pool volume, minimum rates at which water is supplied to the holding pool, and others. These criteria are typically dependent upon site-specific conditions and would need to be incorporated into the design of a fish trapping facility. Additionally, methods must be employed to minimize stress upon fish associated with human activity in the vicinity, such as providing water spray across the entire pool surface or use of a pool cover to prevent fish agitation from nearby human activities. Due to the likelihood of fish jumping within the holding pools, soft netting should be provided or the area over the pool should be darkened to minimize potential for fish injury.

The location of the adult collection facility would be based on physical site characteristics. Requisite site characteristics include accessibility of the facility for upstream migrating adult steelhead and sufficient attraction flows to draw fish into the facility. Additionally, the site must have road access for the tanker truck used in the transport process. Fish are not likely to enter a ladder or off-channel holding pool unless they are presented with a barrier that blocks migration up the main stream channel. To encourage fish to enter the facility, the entrance should be located at a migration barrier, or one should be created, to prevent the fish from traveling farther in an upstream direction without entering the facility.

### **ADULT FISH TRANSPORT (HAUL)**

A survey of fish transportation equipment and techniques used by hatcheries, private producers, Indian reservations, and research laboratories conducted by Carmichael and Tomasso (1988) revealed that among survey respondents, truck-mounted tanks were more common than trailer-mounted tanks and a majority of transport vehicles carried only one tank. More than half of the loading volumes were reported to be between 60 and 500 gallons of water (see photograph [a] on Figure 4-4), with between 501 and 1,000 gallons of water (see photograph [b] on Figure 4-4) being the second most common loading volume class reported. The survey also revealed that fiberglass tanks were the most common type of tank used among respondents and that tanks typically contained some type of insulation. Ice was most commonly used to maintain water temperature rather than refrigeration units, and air venting or infusion of bottled oxygen directly into the water is necessary to maintain oxygen levels sufficient for the fish (Carmichael and Tomasso, 1988). Respondents to the survey reported using tank trucks for transporting a number of salmonid species, including rainbow trout, brown trout, brook trout, coho salmon, and Chinook salmon. Survival rates for adult fish transport are reportedly typically more than 99 percent if fish are in good condition at capture, holding conditions and duration are appropriate, and transport equipment is in good condition and operated appropriately.

### **IMMIGRATING ADULT TRAP AND HAUL AT ACDD**

With this design component, immigrating adult steelhead would be captured below ACDD, transported around the dam, and released at a location above ACDD. Because Little Yosemite, located between ACDD and the Alameda Creek confluence with Calaveras Creek, has been identified as a potential impediment to immigrating steelhead at low to moderate flows, it may be desirable to capture immigrating adult steelhead below Little Yosemite, near the confluence with Calaveras Creek (see Confluence Fish Facility on Figure 4-5). Depending upon release location(s), a fish collection facility at this location could potentially provide access to spawning habitat between Little Yosemite and ACDD, and upstream of ACDD. Pending the completion of more detailed hydraulic studies, the capture facility would likely consist of a small, two- or three-pool fish ladder leading to a holding pool. For the ladder at the Confluence Fish Facility, a pipe could be used to divert gravity flow from upstream on Alameda Creek to the fish ladder. Requirements for the capture location include road access and adequate flow regimes in Alameda Creek to provide attraction flows. A capture facility would need to be located at a permanent or temporary artificially constructed barrier that could block upstream migration during the steelhead immigration period (Table 4-1), thereby encouraging immigrating fish to enter the facility.



(a) A pickup truck adapted for hauling fish, with an approximately 210-gallon aluminum tank.



(b) Large Department of Fish and Game fish transport truck used to stock trout at Lake Davis, California.

**Example Fish Transport Truck Photos**

Feasibility of Fish Passage at Alameda Creek Diversion Dam  
Technical Memorandum

June 2009

Figure 4-4

URS Corp. - Oakland CA - C. Raumann, L:\Projects\Calaveras\_Dam\_26814408\MexiCurrent\_Working\_Documents\B\0\0\0\Fish\_passage\_study\ACDD\Fish\_passage\_ACDD\_Fig-5\_Haul\_Route.mxd

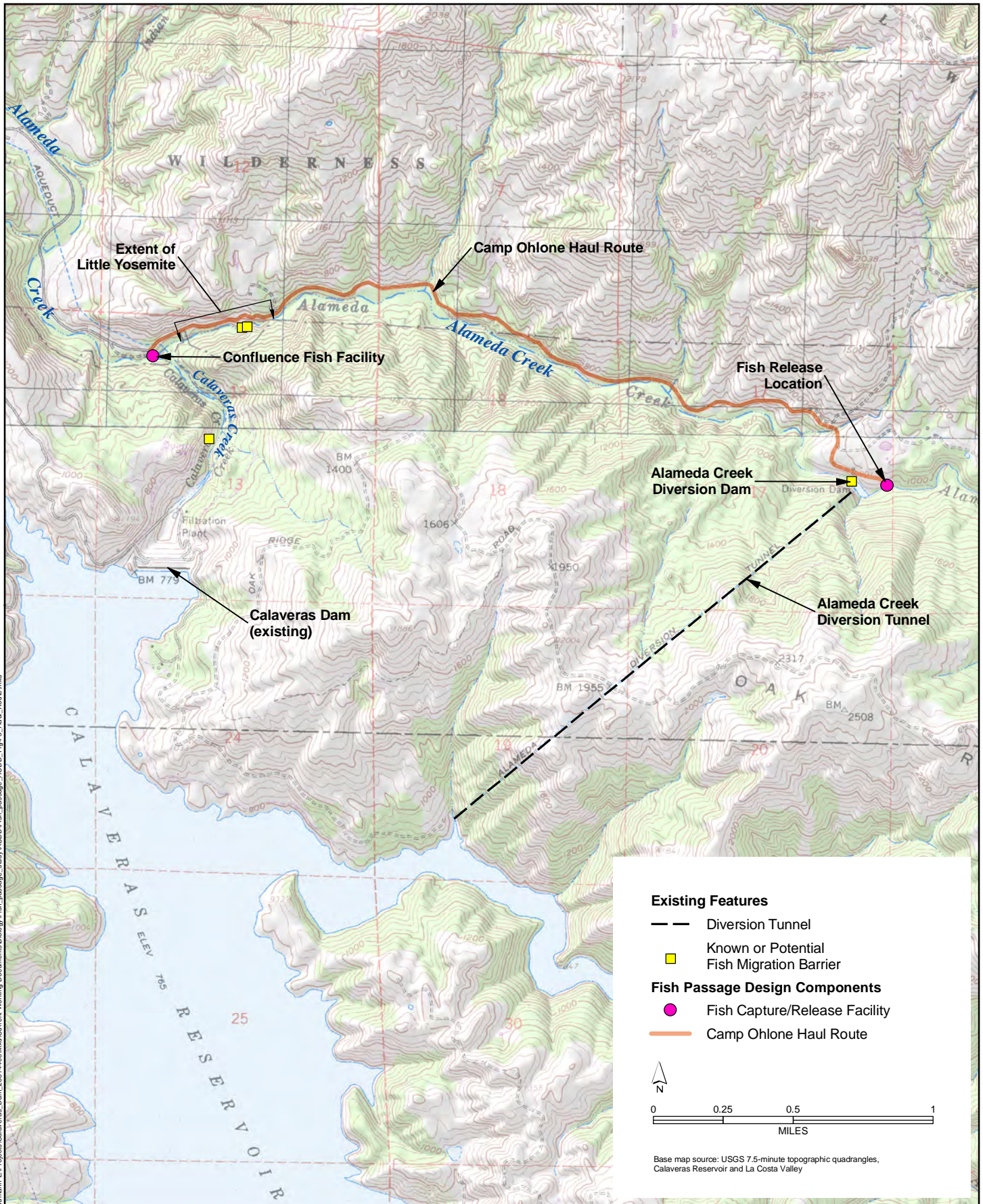

**Existing Features**

- — Diversion Tunnel
- Known or Potential Fish Migration Barrier

**Fish Passage Design Components**

- Fish Capture/Release Facility
- Camp Ohlone Haul Route

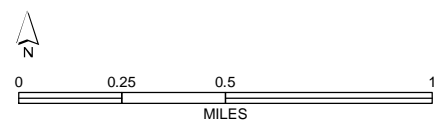

Base map source: USGS 7.5-minute topographic quadrangles, Calaveras Reservoir and La Costa Valley

**Haul Route From Confluence to Above ACDD**

Feasibility of Fish Passage at Alameda Creek Diversion Dam  
Technical Memorandum

June 2009

Figure 4-5

Adult fish would be transported from the collection and holding facility to a release location upstream of ACDD. Water-to-water transfer would likely be used to move the fish from the holding facilities to the transport trucks. Water-to-water transfer requires the fish holding tanks to be elevated above the loading station for the transport truck, and the holding tank drains into the transport truck to transfer the fish without handling injury or related stress. Truck tanks use automatic quick-release gates for the subsequent release of adult fish. Releasing adult fish from trucks requires very little infrastructure other than direct access to the water's edge; therefore, the requirements for adult fish release facilities are minimal (e.g., a boat ramp).

For the purposes of this analysis, it is assumed that a truck-mounted tank would be sufficient to transport the fish. A potential transportation route, the Camp Ohlone Haul Route, is shown on Figure 4-5. The route would connect a potential adult capture location (Confluence Fish Facility) with a potential release location just above ACDD (as opposed to Camp Ohlone, at the end of Camp Ohlone Road), and would be approximately 3.1 miles long. While 2.6 miles of this route is a well-graveled, existing roadway, 0.34 mile is a lightly gravelled roadway, and 0.13 mile lacks a preexisting road. Paving would be required to accommodate frequent trips by a heavy truck during the rainy season, to minimize erosion with the potential for sediment to increase stream turbidity. Improvements would include constructing new segments of roadway at both ends of the existing roadway, provision of creekside access, paving of the entire roadway, provision of truck turnarounds at the upstream and downstream ends of the route, and drainage and safety improvements (i.e., guardrail, bollards, etc.) along the roadway where needed.

If all immigrating steelhead are captured at the Confluence Fish Facility and transported to a release location above ACDD, steelhead would not be able to access approximately 3 miles of Alameda Creek between the confluence and ACDD (Figure 4-5). If it is determined that this habitat is of value for steelhead spawning (see Section 6.1), it should be feasible to allow some steelhead to bypass the collection facility and access portions of this habitat, or to release fish at key locations in this reach where spawning habitat may occur.

Based on its ability to effectively move adult steelhead over ACDD, its engineering simplicity, and the fact that hauling fish is a common means of moving them from place to place, the trap and haul design component is retained for further consideration in this memorandum. Section 5 discusses the order-of-magnitude capital, operations, and maintenance costs for this design component.

#### 4.4 FISH SCREENS

Screening of the ACDT would be necessary in conjunction with passage over ACDD to protect steelhead from being diverted through the ACDT. Fish screens are devices installed at surface water diversions to prevent the entrainment of fish into the diversion intake. If steelhead were entrained in the ACDT, they would be transported to Calaveras Reservoir, where they would be unable to contribute to the reproductive success of a reestablished steelhead population in Alameda Creek.

As analyzed herein, screening applications at ACDD would be consistent with the guidelines and criteria established by NMFS (1997 and 2008) and CDFG (2009), unless deviations from these criteria are recommended and approved. While some assumptions regarding applicable design criteria have been made to conduct the analysis in this memorandum, the specific design criteria for the detailed design of potential screens at ACDD (e.g., effective screen area, submergence, sweeping velocity, screen face opening, approach velocity, and fish bypass design) would be defined in coordination with NMFS and CDFG. Screening typically reduces the amount of water that can pass through a diversion in a given period of time. In order to be suitable for use at ACDT, fish screens

would have to be able to meet the minimum design criteria needed to protect steelhead while simultaneously minimizing the reduction in the diversion capacity of the ACDT.

With all screening systems, sweeping velocity, the presence of a fish screen bypass, and subsequent bypass flow are required at some level. The sweeping velocity maintains flow along the face of the screen, and helps move fish that find themselves in front of the screens to the fish screen bypass. At a structure like ACDD the fish screen bypass would be a conduit that channels some water and any fish from in front of the screens safely through the diversion dam to a point just downstream, where the water and fish would flow back into the stream. The proper design of the fish screen bypass system is critical to successful operation of the screen. For this analysis, it is assumed that operational fish bypass flows are 5 cfs whenever water is being diverted. The fish screen bypass<sup>6</sup> would be designed to provide safe, open-channel, downstream passage for fish, and is presumed to be the primary means by which steelhead would emigrate past the ACDD.

Several different types of fish screening devices have been developed and are used extensively for screening diversions. The configuration, material types, and application of these screening systems vary greatly and are dependent upon several key factors, which may include diversion type (whether gravity or pumped), diversion rate, depth of flow, target fish species, ability to meet agency criteria, maintenance requirements, operational requirements, and other physical site characteristics.

Screens typically require some type of power to clean debris from the screen surface. Because there is no grid electrical power at ACDD, screening would likely require some combination of solar power and batteries, a power generator, hydro power (such as paddle wheels to operate cleaning mechanisms associated with screens), or constructing approximately 3 miles of new electric distribution line from Geary Road. The amount of power that would be required, and therefore the manner in which power would be provided, would be established by detailed design. Since detailed design is beyond the scope of this initial feasibility study, generalized (i.e., typical) power requirements for the various screen types are described in Section 4.4.1.

This section describes and evaluates the screen types and configurations that could potentially be used to protect steelhead<sup>7</sup> from entrainment at the ACDT if passage were implemented (Sections 4.4.1 and 4.4.2, respectively). Screen types used at similar facilities (i.e., rotary drum, vertical traveling, vertical and inclined flat-plate, and horizontal flat-plate screens), and potential screen configurations (in the sediment channel and outside the sediment channel) are presented along with their inherent advantages and disadvantages relative to application at ACDD. The purpose of these sections is to present possible screening concepts and provide some discussion on their inherent suitability for implementation at ACDD. A review of the fisheries literature, combined with site visits, site photographs, and schematics was used to determine potential fish screen designs appropriate for use at ACDD. The most suitable screen concepts are retained for further analysis in this memorandum, and others are rejected based on their incompatibility with the site-specific requirements at ACDD.

---

<sup>6</sup> Two potential fish screen bypass concepts are shown on Figures 4-13 and 4-14.

<sup>7</sup> While not evaluated in this technical memorandum, screening at the ACDT could benefit resident rainbow trout and other resident aquatic resources. The screen-related information discussed in this section may therefore have value independent of steelhead passage at ACDD.

#### 4.4.1 SCREEN DESIGN TYPES

Screen design at ACDD would include selecting the type of screen for use at ACDD, as well as a layout or configuration of screens suitable for use at ACDD. Screen configuration is addressed in Section 4.4.2. In this section, four types of fish screens are evaluated for their suitability at ACDD, and one screen type (vertical/inclined flat-plate screen) that is potentially most suitable for use at ACDD is carried forward for further analysis in subsequent sections.

#### ROTARY DRUM SCREENS

Rotary drum screens are typically used in open channel flow situations such as irrigation canals. This type of screen configuration, using a single or multiple drums, can be used for a fairly large range of diversions (up to 2,800 cfs [WDFW, 2000b]). In operation, water passes through a screen mesh covering a rotating cylinder (Figure 4-6). Automatic cleaning is provided by debris being picked up by the rotating screen and deposited downstream. A static brush may be added to the top of the screen to provide additional cleaning if biological growth is determined to be a potential maintenance issue. The screen rotation may be driven by electrical motor or mechanical means using a paddlewheel and drive mechanism.

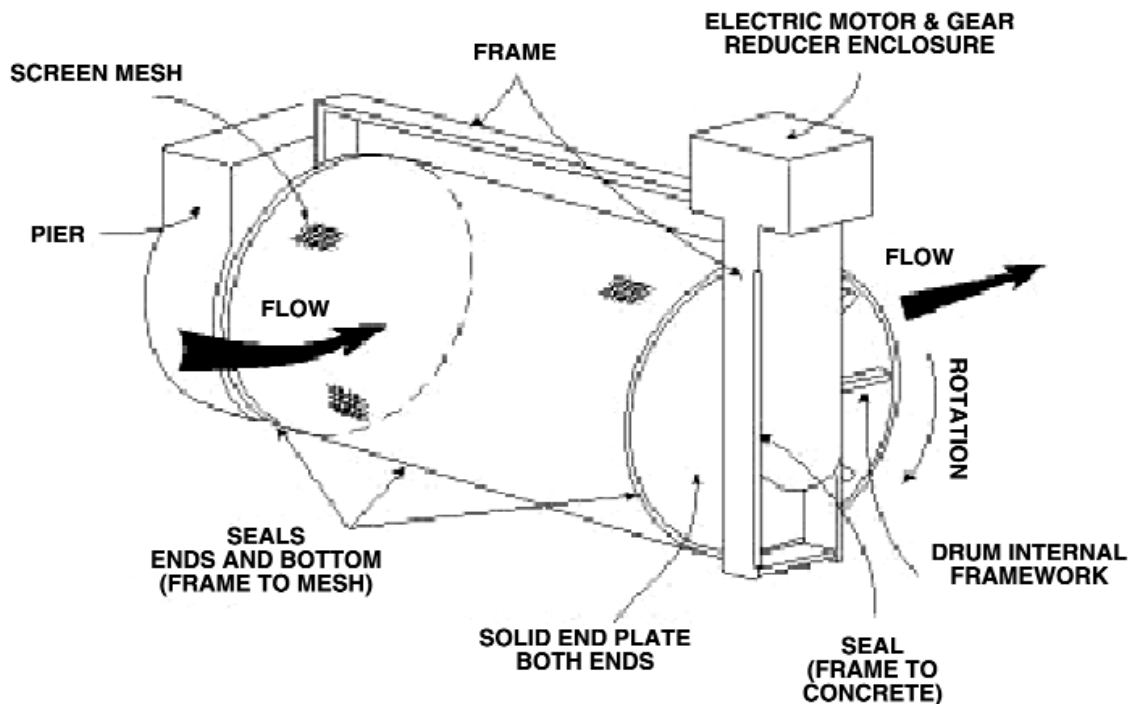

Figure 4-6 Rotary Drum Screen (WDFW, 2000c)

Rotary drum screens must be continuously submerged by 65 to 85 percent, limiting application in areas with even moderately variable flow regimes. At ACDD, this would require operation of the diversion so that the water surface level behind the dam would vary no more than 2.8 feet for a 14-foot-diameter screen. To maintain this narrow range of water surface elevation behind ACDD,



one or both of the gates at the upstream tunnel portals would need to be automatically operated to open and close, thereby maintaining a near constant water level behind ACDD.

An array of rotary drum screens could be incorporated into the existing facility or installed as a new structure at ACDD. Advantages include the self-cleaning nature of the screen and the ability to operate without electricity (using a paddle wheel). Disadvantages include the requirement for relatively stable forebay conditions and the need for multiple structures within the diversion, both of which will limit the diversion capacity of this type of screen system in this application. Therefore, it appears that rotary drum screens are not suitable for use at ACDD, and they are not studied further in this analysis.

## VERTICAL TRAVELING SCREENS

A schematic of a typical vertical traveling screen is shown on Figure 4-7. Two types of screens are commonly used: panel and belt. The difference in the two types is in the screening mesh. Panel type screens have many discrete meshed panels hinged together, while belt types use a continuous belt mesh. Both types of screens can be driven by electric motors (WDFW, 2000b) or mechanically with paddlewheel and drive mechanisms. Many types of cleaning systems can be used with the vertical traveling screen, including a static brush mounted on top of the screen and/or water jets mounted on the back of the screen. The use of water jets would require an electrical power source and jet pressurization equipment. Vertical traveling screens are effective and can be implemented readily as long as careful consideration of the critical design criteria and specific nuisances are taken into account during the design process.

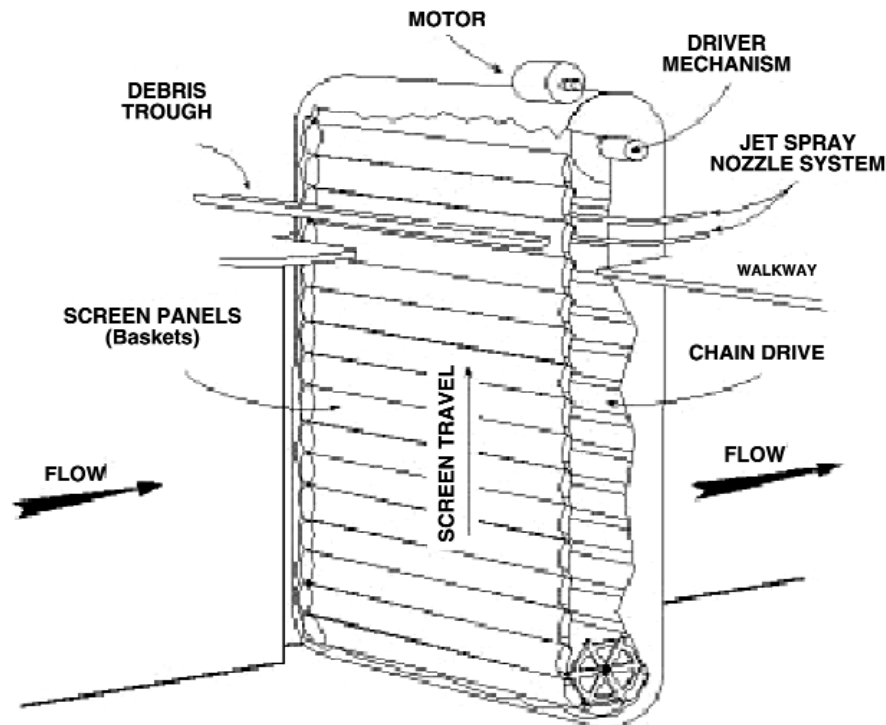

Figure 4-7 Vertical Traveling Screen (WDFW, 2000c)

At ACDD, this type of screening system would require a series of screens mounted across the existing diversion. These screens can be fabricated in a number of height and width configurations to meet the needs of local site characteristics, submergence requirements, forebay fluctuation, and approach

velocities. A support structure and walkway across the diversion could provide guideslots for the screens and velocity baffles for ease of installation and for performing routine maintenance.

Advantages of the vertical traveling screen include its ability to be self cleaning; flexibility in height so that variances in forebay can be addressed; and ability to operate without electricity (using a paddle wheel). Disadvantages include its requirement for routine maintenance due to the presence of several moving parts; and reduction of the effective screen area and associated diversion rate due to the presence of gear mechanisms at top and bottom as well as rollers and frames along the sides. It appears that this type of screen may be suitable for use at ACDD, but this type of screen is not studied further in this analysis because it has typically higher maintenance costs (due to more moving parts) than the other types of screens.

## **VERTICAL AND INCLINED FLAT-PLATE SCREENS**

Flat-plate screens can be oriented vertically or at an incline. The application of these two configurations is generally the same, with the caveat that due to a recent acceptance by NMFS in appropriate applications, the effective screen area of incline screens can be calculated using the actual screen area rather than the vertical projection of the screen alone. In such cases, inclined screens may provide additional effective screen area over vertical screens when compared over the same screen length, because by tilting the screen away from the horizontal plane, more of the screen can be submerged in the same depth of water.

Vertical and inclined flat-plate screening systems are among the most common screen types in use. They are used for irrigation, domestic, and industrial intakes at both pump and gravity diversions. Vertical flat-plate screens are relatively easy to seal because the screen mesh is fixed directly to the structural frame. The absence of moving parts between the mesh and screen frame also reduces maintenance. The disadvantage of a vertical flat-plate screen is that cleaning systems must operate at regular intervals and debris management systems must have automatic systems that trigger when debris loads increase. Automatic cleaning is triggered by a high-level water differential across the screens, an elapsed time period, or manual activation. Potential cleaning systems vary and include air burst, water jet, and mechanical brush mechanisms. These devices are normally powered by electric motors and require a power supply. Baffles located behind the screens are used to create uniform approach velocities across the screens. A schematic diagram of a vertical flat-plate screen installation and typical cross section are shown in Figures 4-8 and 4-9, respectively. Figure 4-10 illustrates a typical inclined flat-plate fish screen, and Figure 4-11 shows a photo of a working vertical flat-plate fish screen.

The vertical flat-plate fish screen is potentially suitable for use at ACDD. Like the vertical traveling screen, a series of structural supports, a walkway, and several screen panels would be required. Some of the advantages of the flat-plate screen are that there are no moving parts on the screen itself (only potentially the cleaning system) so annual maintenance may be less than other screen types, the screen can be configured in a wide variety of lengths and heights to remain effective over the range of forebay fluctuations, there is less structural blinding and more effective area on average than other screening systems, and the cost associated with fabrication of flat-plate screens is less than for other screen systems. (Structural blinding is the reduction of flow through portions of the screen that are blocked by screen support structures.) Additionally, one potential configuration of the screen would fit within the existing diversion structure at ACDD (i.e., behind the existing trash rack), minimizing installation and construction costs while fully using existing structures. The disadvantage of these screen systems, as mentioned previously, is that an automated cleaning system is required to control debris accumulation at the face of the screen and maintain uniform approach velocities throughout the submerged portion of the screen. The flat-plate screen is retained for further analysis in this technical memorandum because it is used widely for screening diversions, is likely to work at ACDD, and typically has lower capital and maintenance costs than the vertical traveling screen.

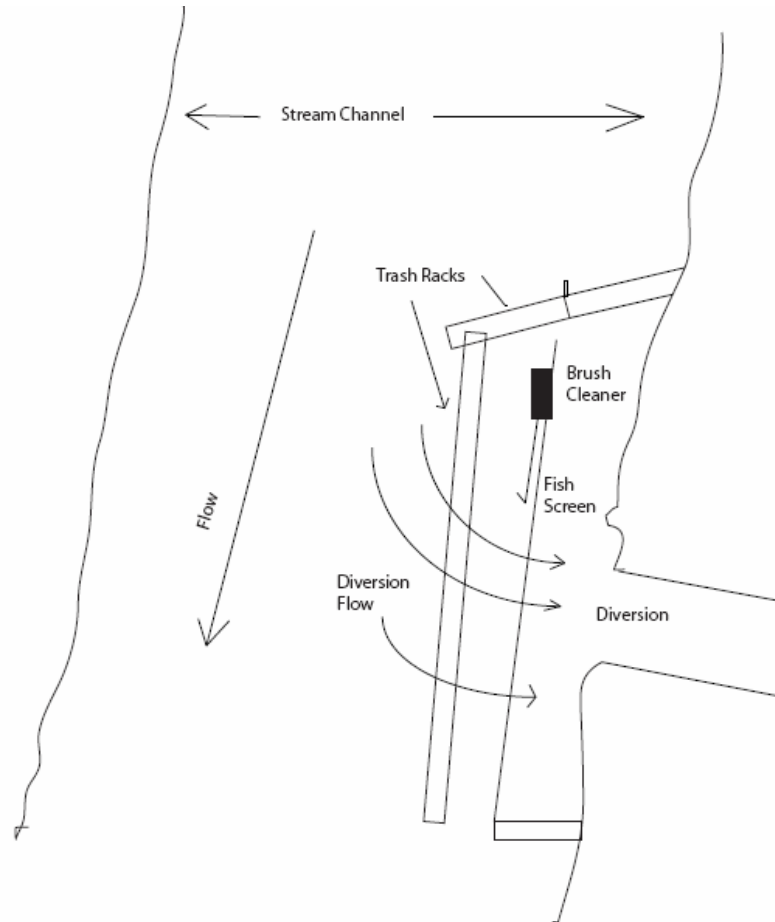

Figure 4-8 Schematic Diagram of Typical Vertical Flat-Plate Fish Screen Installation

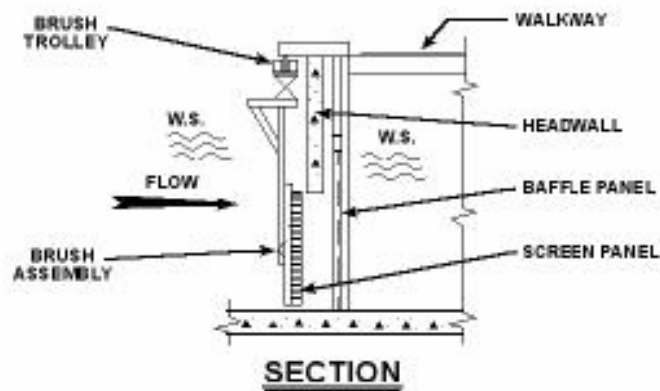

Figure 4-9 Typical Vertical Flat-Plate Screen

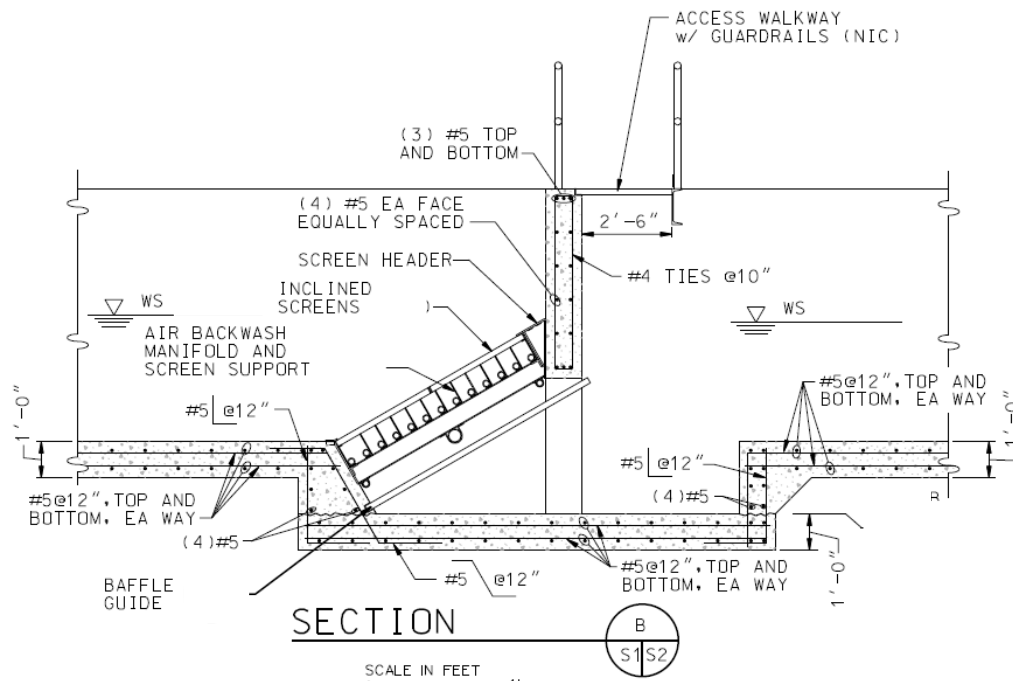

Figure 4-10 Typical Inclined Flat-Plate Screen

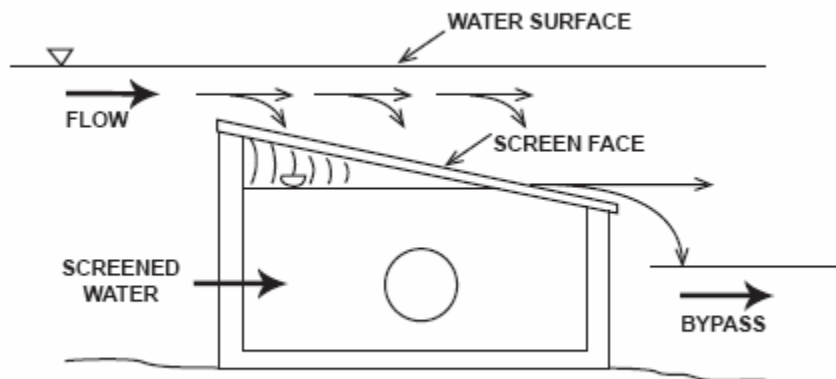

Figure 4-11 Vertical Flat-Plate Fish Screen in Operation

### HORIZONTAL FLAT-PLATE SCREENS

Flat-plate screens may also be oriented horizontally such that water sheets over the top of the fish screen. This type of configuration has been deemed “experimental” by NMFS and therefore flat-plate screen installations require much greater scrutiny during design and operation. Installations of this screen type generally occur where resident fishes are present and the lack of anadromy precludes the

need for NMFS approval. Several installations located in the Pacific Northwest are currently being reviewed and evaluated by NMFS to determine whether they have the potential to harm emigrating juvenile and post-spawn adult steelhead that may travel across the screen during low flow conditions. As with all of the other screen types, a fish bypass would be required at the end of the screen to return debris and emigrating steelhead downstream. A schematic diagram of a downward-sloping horizontal flat-plate screen is depicted in Figure 4-12.



**Figure 4-12 Horizontal Downward-Sloping Flat Plate Screen**

As shown in Figure 4-12, a horizontal flat-plate screen operates by allowing a percentage of the flow over the screen to pass through it. The flow that passes through the screen falls into a canal below the screen where it is routed as required. Operation of this screen is very sensitive to the minimum depth of surface water bypassing the diversion. Normally a minimum depth of 12 inches is required (WDFW, 2000a).

An advantage of the downward-sloping horizontal screens is that, if designed properly, they are inherently self-cleaning as debris is removed by the normal stream flow. Disadvantages include the potential for non-uniform approach velocities across the screen, sensitivity to fluctuating forebay elevations, and the “experimental” nature as defined by NMFS. For these reasons, this type of screen is not analyzed further for use at ACDD in this report.

#### 4.4.2 POTENTIAL SCREEN CONFIGURATIONS

As described in Section 4.4.1, vertical/inclined flat-plate screens and vertical traveling screens may both be suitable for use at ACDD. For the purposes of this analysis, only vertical or inclined flat-plate screens have been carried forward. These types are used widely and typically cost less than traveling screens. Vertical flat-plate screens could be installed in several configurations at ACDD. For each type, it is necessary to carefully consider how sweeping velocity and approach velocity can be kept uniform across the face of the screen and how effective operation of the fish bypass facility can be maintained throughout the range of forebay fluctuations. In this section, two conceptual-level screen configurations have been identified to protect steelhead from entrainment at the ACDD intake. Each screen configuration will require modification of the existing diversion structure in order to be effective. For purposes of this discussion, the area behind the existing trash racks and fish screen is referred to as the sediment channel. Two potential configurations are shown in Figures 4-13 and 4-14:

- Installing a screen system in the sediment channel behind the existing trash rack.
- Constructing a new screen structure outside of the sediment channel in front of the existing structure, and reusing the foundation of the existing trash rack or replacing it altogether.

The feasibility of each location listed above is evaluated based upon corresponding physical and technical constraints and fish screen design criteria.

Each configuration has its own advantages and disadvantages, both in terms of cost of implementation and maximum allowable diversion rates. All of the design configurations will require a fish bypass flow estimated at 5 cfs, which will return flow to Alameda Creek downstream of the facility, and a power source for operation of the required automatic cleaning mechanism.

### **SCREEN SYSTEM IN THE SEDIMENT CHANNEL**

This configuration involves the placement of a fish screen in the sediment channel as shown in Figure 4-13. The maximum amount of allowable diversion is a function of approach velocity and screen area. A minimum screen area of 1,600 square feet would be required to maintain the existing diversion capacity of the ACDT. Installation of the screen behind the existing trash rack, depending on the angle of incline or angle of orientation with the diversion channel (skew) at which the screen is placed, would likely limit screen area to approximately 1,000 square feet because much of the surface area is composed of beams and the existing walks. At 1,000 square feet, diversion capacity would likely be limited to a maximum of 260 cfs. The effective screen area may be increased by placing the screens at an incline; a greater exaggeration of the skew and incline results in greater effective surface area of the screen. However, it may decrease the uniformity of the flow velocity passing through the screen, and flow uniformity is one of the screen criteria regulated by NMFS (2008). This configuration would require a new steel support structure, a walkway on top of the screen, baffle guides and baffle assembly, flat-plate screen panes, and installation of a fish screen bypass.

A fish screen bypass via a notch in the crest of the dam was evaluated, but is rejected from further consideration. In order to pass water at all levels of diversion, the notch would have to extend from the dam crest to below the invert of the worker access tunnel within ACDD, which is a vertical distance of approximately 15 feet. This was determined to be an unacceptable solution because (1) a large hollow gallery in the dam that provides access to the left side of the dam would be blocked by such a notch, (2) the engineering challenges associated with preventing water from bypassing the diversion through the notch at high flows would be significant, and (3) the structural integrity of the dam could be compromised by such a notch. A fish screen bypass through the gravity wall of the sediment channel was determined to be a better solution.

The fish screen bypass could be configured as a tunnel through the gravity wall. Open channel flow is typically required to protect fish in the bypass from injury. It may be possible to modify the previously designed CDRP-proposed stream flow bypass tunnel for use as the fish screen bypass tunnel. In order to limit the fish screen bypass flows to 5 cfs, and to maintain an open channel in the bypass that would provide safe passage for fish, a concrete control structure could be installed at the screen exit to accommodate a range of water elevations. The control structure could potentially be designed to accommodate water and fish from several openings at different elevations, thereby functioning for a variety of water surface elevations. Further analysis of the fish bypass would need to be developed upon design.

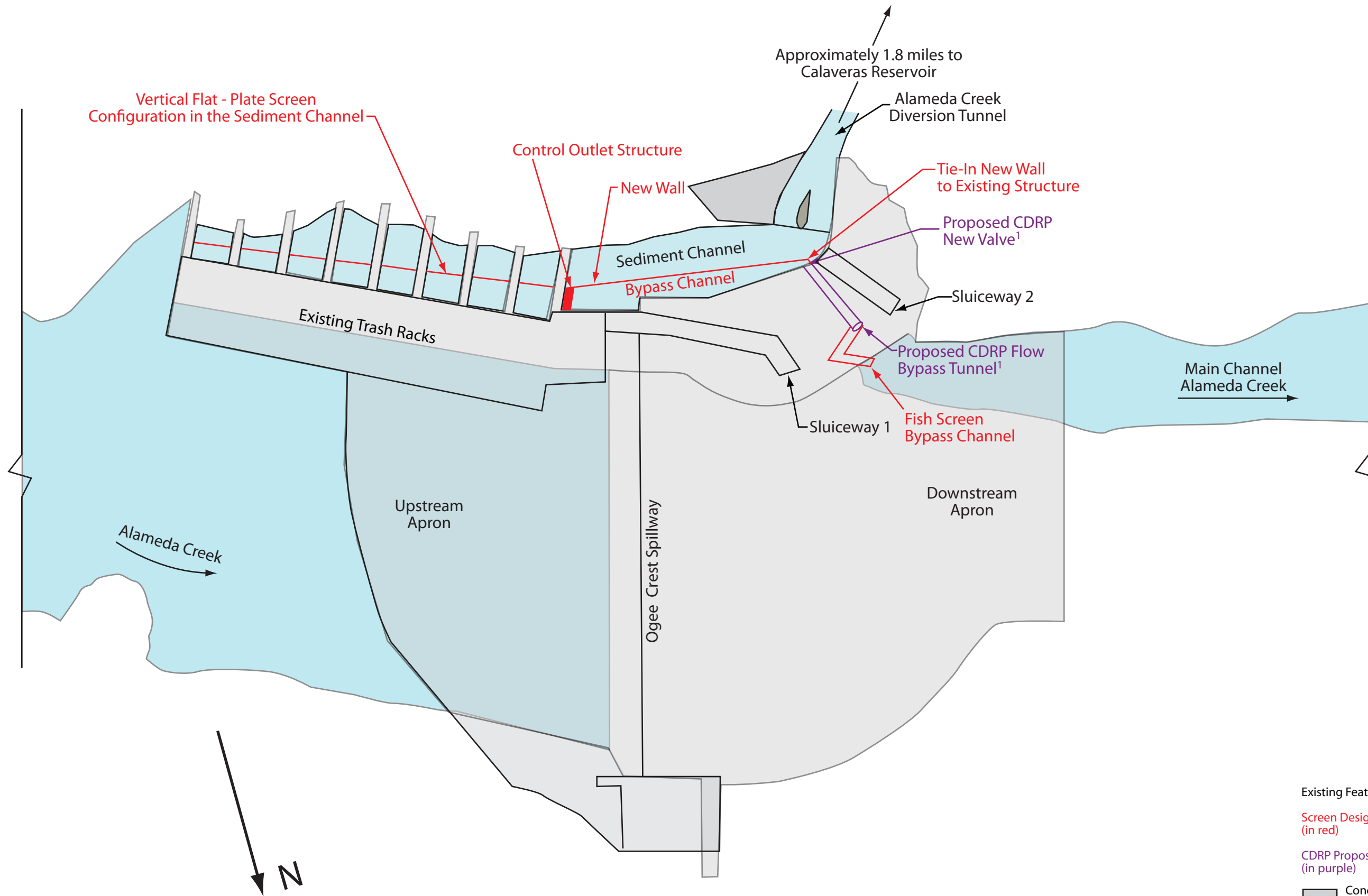

Plan  
Not to scale

- Existing Features (in black)
- Screen Design Components (in red)
- CDRP Proposed Features (in purple)
- Concrete Diversion Dam Structure
- Alameda Creek

<sup>1</sup>Based on URS 2008 and SFPUC 2008a





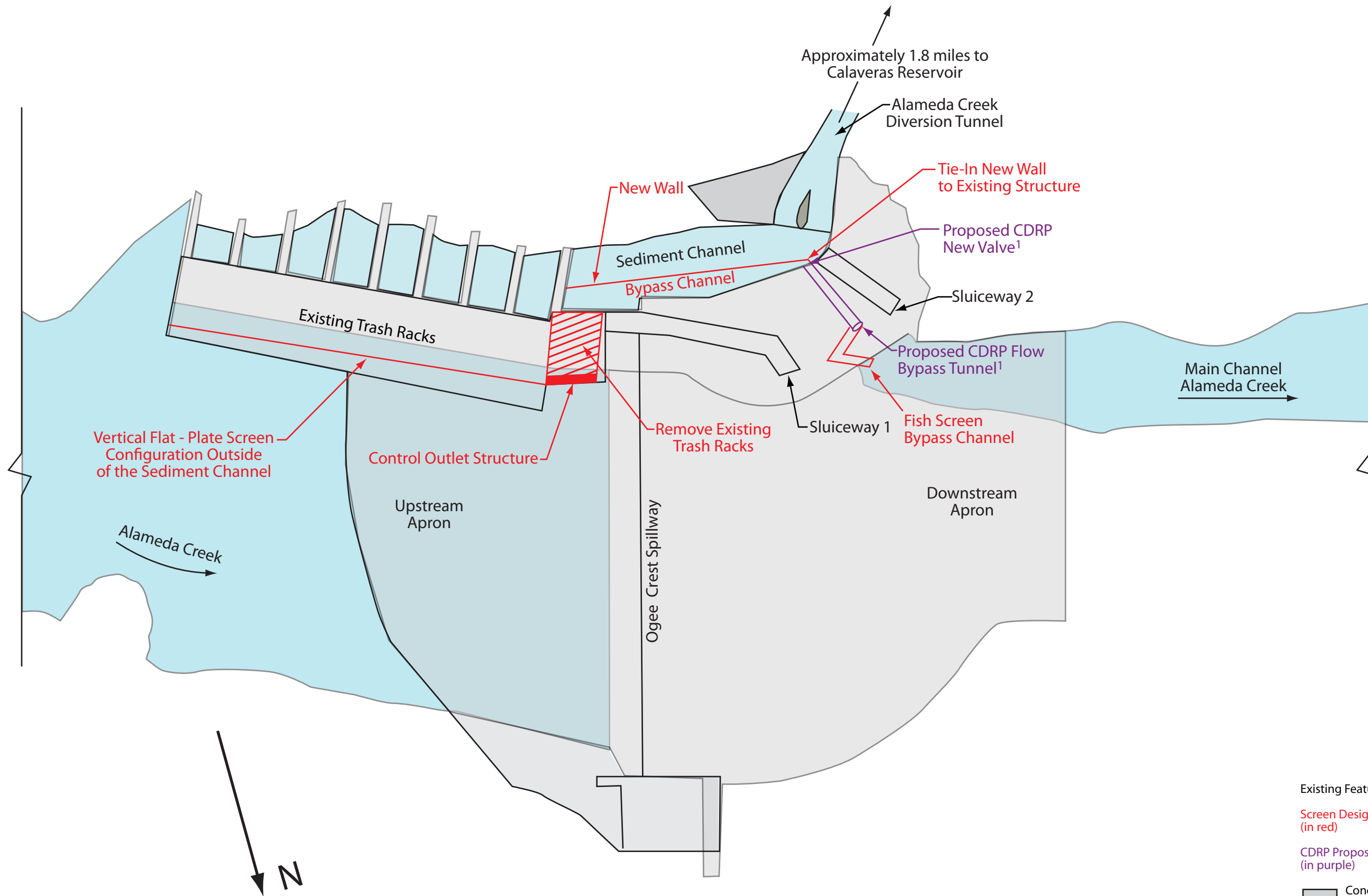

Plan  
Not to scale

<sup>1</sup>Based on URS 2008 and SFPUC 2008a



Potential benefits of configuring fish screens in the sediment channel behind the existing trash rack facility include:

- This configuration minimizes modifications to the existing trash rack configuration.
- This configuration provides the ability to maintain use of one or both existing sluiceways for dam maintenance.

Potential design drawbacks include:

- The physical constraints of installing the screening system in the existing sediment channel would reduce diversion capacity.
- This configuration would require extensive modification of the existing facility. Geotechnical and structural considerations would need to be addressed during the design process to ensure that it remains structurally sound.

This configuration would result in major modifications of the existing diversion channel and a substantial reduction in diversion capacity; therefore, it is not analyzed further in this report.

## **SCREEN SYSTEM OUTSIDE OF THE SEDIMENT CHANNEL**

This configuration involves removing the existing trash rack, and replacing it with a new trash rack and fish screen combination using current fish protection design. The new screen system could be provided on the foundation of the existing trash rack, if it is strong enough to support the screens and a trash rack, or farther in the channel to the north of this location as shown on Figure 4-14. The structural integrity of the existing trash rack's foundation would require evaluation if its incorporation into a screen facility was to be implemented.

Replacing the existing trash rack with a fish screen structure would provide a larger area for screens than the sediment channel could accommodate, potentially up to 1,400 square feet, thereby increasing the diversion potential compared to limiting screens to within the sediment channel.

In this configuration, the fish bypass would be similar to the previous configuration, as shown on Figure 4-14. This configuration would have the following advantages:

- Modernization of the facility, such as the potential to include state-of-the-art construction and screening materials and apparatus.
- Greater flexibility to develop an integrated trash rack, fish screen, and screen-cleaning mechanism without the constraints of the existing structure.
- Greater potential to develop more effective screen area than the previous alternative and thus maximize potential diversions, while meeting all biological and operational criteria.

This configuration would have the following disadvantages:

- Depending upon the design, it could result in obstruction within the main channel that will collect additional debris in major storm events compared to the existing trash rack system.
- It could result in disturbance and changes to the existing flow regime as well as changes in historical sediment deposition patterns and general stream geomorphology, which may increase

difficulty of debris and sediment maintenance via sluicing. Engineering solutions to potential sediment issues, however, are feasible.

While this configuration would likely be the more expensive to construct, the probability of success with respect to fish protection and water diversion may be higher than with screening inside the sediment channel. Therefore, this screen configuration is retained for further analysis in this memorandum.

If the existing trash rack and diversion structure were completely demolished, it may be possible to install a V-type screen. A side-channel V screen is commonly used for water diversions in California and can comply with regulatory requirements. The bottom point of the V typically points down stream, and fish are collected for bypass from the downstream center of the V. This type of arrangement would require major modifications of the sediment channel. For example, the channel could be re-constructed in a manner that would accommodate the V screen within the channel. One benefit of this type of arrangement is the potential to fit more screen area into less space, which may help maintain the existing diversion capacity of the ACDT. Another advantage is that the trash rack can typically be set at the point of diversion, with the screens farther back in the channel, so that the hydraulic influence of the trash rack on the approach velocities at the screens is eliminated. Typically a standard brush cleaning system is used with V screens, in compliance with NMFS and CDFG regulations. A fish screen bypass would be required, as described above. This type of screen configuration at ACDD may require more extensive review from NMFS and CDFG, because it is considered off-channel screening and is typically used in canals. It may be appropriate and justifiable at ACDD, however, due to site constraints. If the side channel is considered a canal, a 0.4-foot-per second (fps) approach velocity may be applicable (CDFG, 2009), thus shortening the required screen length. Discussion with relevant resource agencies could be conducted to determine suitability at ACDD. If approved, the suitability of V screens could be further evaluated during any future screen planning and design. However, given that such a use is somewhat speculative, V screens are not evaluated further in this memorandum.

## 5 CAPITAL AND OPERATING AND MAINTENANCE COSTS

In the previous section, design components were identified and evaluated based on their ability to meet the biological requirements of adult steelhead immigration, and screened for suitability at ACDD. The design components evaluated in this section were retained for further consideration because they are more likely to meet the biological requirements of passage and are considered to be generally suitable for this location. In cases where multiple variations of a design component could potentially be suitable at ACDD, an effort was made to select the design component that appeared most favorable, based on potential cost, biological suitability, and engineering feasibility, and only carry forward that design component. The following design components were retained through the preliminary analysis, and are evaluated in this section based on cost:

- Fish ladder
- Trap and haul
- Fish screens

The estimated cost of fish passage, including screening, is presented in the following sections based on capital costs of construction (Section 5.1), estimated cost of lost water diversion opportunities associated with fish ladders and screening (Section 5.2), and the total annualized cost of each design component alone and in combinations that together provide complete fish passage options (Section 5.3).

### 5.1 CAPITAL COSTS

The cost of passage and screening design components at the ACDD includes both the capital cost of constructing the facilities and annual operations and maintenance costs. This section describes the estimated capital costs associated with the design components retained through the initial analysis.

Capital cost estimates are provided based upon facilities at other sites where similar projects have been implemented, as well as typical industry costs and engineering judgment. Each design component was evaluated on a conceptual level, taking into consideration basic factors such as site conditions and conceptual designs. When sufficient information was available, capital costs for the design components were estimated by developing unit costs and multiplying these by estimated quantities. Unit costs were compared with historical database unit prices; vendor quotes were used, when available. Where the level of design detail was insufficient to support an estimate, lump sum allowances based on historical experience for similar projects were used. Raw capital costs were then generated for each design component. Estimated raw costs and additional assumptions are detailed in Appendix A.

As described in Section 4, the Long Fishway and the screen configuration outside of the sediment channel have been carried forward in this memorandum. Comprehensive design work has not been done for any of the design components. For purposes of analysis, relative cost estimates were developed. Raw capital costs presented in Table 5-1 are based on the limited descriptions of the design components provided in Section 4 and assumptions regarding the types of materials presented in Appendix A.

The SFPUC Water System Improvement Program (WSIP) program delivery cost methodology (SFPUC, 2006) was used to determine the factor to add to the raw construction cost to develop a total estimated capital cost for each design component (Table 5-1). The total factor of 100 percent consists of an estimate contingency (25 percent), construction escalation to time of construction (24 percent), construction contingency (10 percent), and soft costs (e.g., planning, design, review, management, etc.) (41 percent).

Design Component	Raw Cost <sup>1</sup>	Soft Costs and Contingency (100%) <sup>2</sup>	Total Capital Cost <sup>3</sup>
Long Fishway	\$5,251,000	\$5,251,000	\$10,502,000
Confluence Fish Facility	\$803,000	\$803,000	\$1,606,000
Camp Ohlone Haul Route	\$3,270,000	\$3,270,000	\$6,540,000
Fish Screens	\$6,610,000	\$6,610,000	\$13,220,000
Notes: <sup>1</sup> Back-up for raw cost shown in Appendix A. <sup>2</sup> 100% factor includes the following: (a) Estimate Contingency 25%, (b) Construction Escalation 24%, (c) Construction Contingency 10%, and (d) Soft Costs 41% (SFPUC, 2006). <sup>3</sup> Order-of-magnitude costs estimated are based on current rates in 2009 dollars.			

A number of limitations are associated with the estimates provided. The costs are preliminary, order-of-magnitude<sup>8</sup> estimates to assist in the comparison of relative costs among options. No engineering site work or calculations have been performed. Depending upon geotechnical and hydrological conditions at the site, it may not be feasible to construct certain components as assumed. In addition, environmental impact mitigation costs could be required with implementation of some or all options. These mitigation costs are not included in this estimate.

## 5.2 LOST WATER DIVERSION COST ESTIMATION

Because SFPUC is a supplier of municipal water, reductions in the amount of water diverted at ACDD to Calaveras Reservoir will result in most cases in a cost for replacement water. Therefore, a component of the annual fish ladder and screen operating costs is the lost water diversion opportunity costs. The water potentially unavailable for diversion to Calaveras Reservoir with the implementation of fish passage could include:

- A reduction in diversion capacity due to screening (Section 5.2.1)
- Water bypassed at a fish screen to maintain required sweeping flows and downstream passage (Section 5.2.2)
- Water bypassed to operate a fish ladder (Section 5.2.3)

These lost water diversion opportunities are described in more detail in this section, and estimates are provided for the costs associated with each lost water diversion opportunity, along with associated assumptions and limitations (Section 5.2.4).

<sup>8</sup> An order-of-magnitude cost estimate is also known as a concept Class 5 estimate (AACE, 2005). Its primary use and purpose is to screen alternatives and determine feasibility. Expected accuracy ranges from -20% to -50% on the low end, and +30% to +100% on the high end.

### 5.2.1 REDUCTION IN DIVERSION CAPACITY DUE TO SCREENING

The capacity of the ACDT to transfer water to Calaveras Reservoir would likely be reduced if screening was implemented according to the criteria described by NMFS (1997 and 2008) and CDFG (2009). In general, fish screening criteria include a combination of (1) low approach velocity, and (2) adequate sweeping velocity. Approach velocity is defined as the velocity of water that passes through a screening device perpendicular to the screen openings. Sweeping velocity is the velocity of water that runs parallel to the screen openings. At ACDD, the sweeping velocity requirement would be met by providing a fish screen bypass at the downstream end of the screens. Water costs associated with the fish screen bypass are addressed in Section 5.2.2. The purpose of this section is to quantify reductions in the amount of water that could be diverted to Calaveras Reservoir due to potential reductions in the maximum rate at which water could be diverted through the ACDT, if screening was implemented.

The current maximum diversion rate through the ACDT is estimated to be approximately 650 cfs. When screens are used, an approach velocity of 0.33 fps<sup>9</sup> is typically required by CDFG (2009) to protect fish from impingement. NMFS (1997 and 2008) also has approach velocity criteria, which vary depending upon site specifics. At ACDD, NMFS criteria would be less restrictive than CDFG’s (2009), so the CDFG criterion is used for the purposes of analysis in this memorandum. Approach velocity and diversion rate are related to screen area; for a given rate of diversion, a larger screen area will result in a lower approach velocity. Alternatively stated, for a given approach velocity, increasing the screen area increases the maximum potential diversion rate, as shown on Figure 5-1. Therefore, a primary constraint during screen design is the size of screen that a site can accommodate. Because of the site constraints and

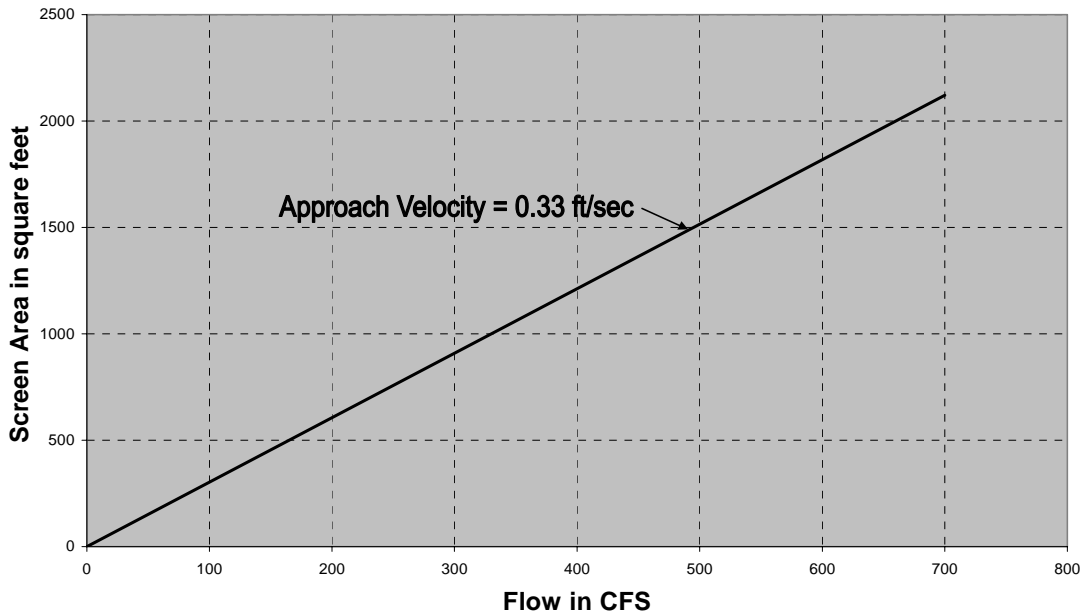

**Figure 5-1 Flow versus Required Screen Area**

<sup>9</sup> The screen approach velocity at ACDD would be determined in coordination with NMFS and CDFG.

the need to maintain the specified approach velocity, the installation and use of fish screens at ACDD would result in a reduction in the amount of water available for diversion to Calaveras Reservoir for use as municipal water supply.

It is estimated that a maximum screen area of 1,400 square feet could be accommodated outside of the sediment channel at the ACDD. With any screening installed at ACDD structural supports, baffles, and other infrastructure would cause some structural blinding. Structural blinding typically reduces the effective screen area by 20 or 30 percent. To account for anticipated structural blinding, a reduction of approximately 20 percent was applied to the estimated maximum screen area for a reduced screen area of 1,120 square feet. Based on the relationship shown in Figure 5-1, after accounting for structural blinding, the estimated maximum flow rate of the diversion would be limited to approximately 370 cfs. By comparing daily average flows in Alameda Creek with the estimated maximum diversion flow rate of 370 cfs, the potential reductions in annual water diversions with screening at the ACDD can be estimated.

At the time estimates of the cost of this lost water diversion opportunity were first developed, the hydrologic record for upper Alameda Creek (USGS 11172945) extended only from 1995 to 2004. This is a relatively short period of record and may not accurately characterize the temporal distribution of unimpaired flows that could potentially occur above ACDD. To more accurately predict the frequency and magnitude of unimpaired flows that could potentially be available during the diversion period (November through April), a synthetic hydrology was produced based on a correlation with the unimpaired daily average flows recorded at the Arroyo Hondo gage (USGS 11173200) from 1969 to 1981 and 1995 to 2004 (no flow data are available from Arroyo Hondo for the period from 1982 through 1994). This analysis was completed to estimate potential water yields above ACDD over a broader range of hydrologic conditions by extending the period of record from 10 years to 24 years. Appendix B contains a description of the model selection process and detailed flow data.

In support of the limited record of measured flow data for upper Alameda Creek, predicted daily average flows from the model described in Appendix B were used to estimate an unimpaired flow for each day of each year in the simulated period. These daily unimpaired flows were then used to calculate the difference in potential diversion volumes at ACDD between screened and unscreened diversions during the typical ACDD operational period of November through April.

Table 5-2 is a comparison of the total annual (water year) diversion with and without screening, as predicted by the model for simulated flows for the time periods 1969 through 1981 and 1995 through 2004. The following list describes each column in the table.

- Total Flow represents the total simulated flow in upper Alameda Creek for the period of record during the November-through-April water diversion time period.
- Unimpaired Diversion (without screens) represents the estimated amount of water that could be diverted under simulated flows if all flows up to 650 cfs were diverted through ACDD during the November-through-April time period.
- Unscreened Diversion with Schedule B Bypass Flows represents the estimated amount of water that could have been diverted under simulated flows if bypass flows consistent with the SFPUC-proposed normal water year instream flow schedule<sup>10</sup> (Section 2.3.2.2) were bypassed downstream at ACDD, while other flows up to 650 cfs were diverted during the November-through-April time period.

---

<sup>10</sup> As referred to here and subsequently in this memorandum, the term “SFPUC-proposed instream flow schedule” also includes the WSIP Final PEIR mitigation flows detailed in Section 2.3.2.2.



<b>Water Year</b>	<b>Total Flow (acre-feet)</b>	<b>Unimpaired Diversion (acre-feet)</b>	<b>Unscreened Diversion with Schedule B Bypass Flows (acre-feet)</b>	<b>Screened Diversion with Schedule B Bypass Flows (acre-feet)</b>	<b>Lost Diversion Opportunity due to Screening (acre-feet)</b>
1969	29,600	29,000	24,900	20,700	4,200
1970	13,300	13,300	10,000	8,700	1,280
1971	10,500	10,500	7,500	7,300	180
1972	2,710	2,710	1,400	1,400	0
1973	30,500	30,400	25,900	23,900	1,930
1974	22,500	22,500	18,000	16,500	1,560
1975	23,100	23,000	19,500	18,000	1,430
1976	490	490	0	0	0
1977	360	360	0	0	0
1978	22,000	21,900	17,900	15,500	2,400
1979	9,420	9,420	6,500	6,300	230
1980	24,700	22,600	19,000	14,800	4,200
1981	8,250	8,250	5,900	5,100	790
1995	30,200	27,500	23,500	20,200	3,300
1996	23,300	22,500	18,400	16,100	2,400
1997	29,500	28,300	24,600	20,700	4,000
1998	40,800	39,500	35,000	30,600	4,400
1999	13,100	13,100	9,000	8,500	480
2000	14,600	14,600	11,500	10,500	1,000
2001	7,820	7,820	5,200	5,100	130
2002	6,280	6,280	3,500	3,500	0
2003	10,200	10,200	7,700	7,200	440
2004	8,720	8,720	6,200	5,800	420
<b>Average</b>	<b>16,600</b>	<b>16,200</b>	<b>13,100</b>	<b>11,600</b>	<b>1,510</b>

- Screened Diversion with Schedule B Bypass Flows represents the estimated amount of water that could have been diverted under simulated flows if bypass flows consistent with the SFPUC-proposed normal water year instream flow schedule were bypassed downstream at ACDD, while other flows up to 370 cfs were diverted during the November-through-April time period.
- Lost Water Diversion Opportunity due to Screening compares the two different diversion scenarios (i.e., unscreened and screened) and quantifies the volume of water that would potentially not be diverted after screen implementation. Consistent with the order-of-magnitude cost estimating in this conceptual feasibility study, the SFPUC-proposed “normal water year” instream flow schedule (Schedule B) was used in this diversion comparison scenario.

The estimates depicted in Table 5-2 indicate that on average, use of screens results in an annual diversion reduction of approximately 1,510 acre-feet of water that could have been diverted in an unscreened diversion condition. Annual reductions in diversion for both a wet and a dry water year are illustrated in Figure 5-2. For the purposes of this analysis, the average annual diversion reduction of approximately 1,510 acre-feet of water was used to estimate the annual diversion reduction due to screening facility operation. An estimated 2016 water rate of \$1,500 per acre-foot<sup>11</sup> was used in this analysis because it accounts for the time differential of up to several years between this estimate and the actual construction and operation of a potential fish ladder. Therefore, the annual lost diversion opportunity cost due to reduced diversion capacity with screening is approximately \$2,265,000. This water cost is added to the annualized screen component cost in Section 5.3.

### 5.2.2 FISH SCREEN BYPASS FLOWS

Fish screening would require bypass flows at the downstream end of the screens, to maintain sweeping velocity and prevent fish and small debris from being impinged on the screens, and to provide safe downstream passage for fish (NMFS, 2008a). The volume of water available for diversion to Calaveras Reservoir would be reduced due to this requirement.

For purposes of cost estimation it is assumed that the fish screen bypass would require 5 cfs of flow, whenever flows sufficient are available, during the entire diversion period. The estimated annual water cost calculation (Section 5.2) assumes that the SFPUC-proposed normal water year instream flow schedule bypass flows (Section 2.3.2.2) will be used to operate the fish screen bypass when they are available. Because the SFPUC-proposed flows (dry, normal, and wet years) would always be sufficient for operation of a fish screen bypass (5 cfs minimum), it is assumed that there is no additional annual water cost associated with the operation of the fish screen bypass alone. The entire water cost associated with screening is due to the potential reduction in the maximum rate of diversion with screening, as described in Section 5.2.1.

### 5.2.3 FISH LADDER OPERATION FLOWS

Operation of a fish ladder at ACDD would require a prescribed set of minimum flows, when available, to be maintained prior to any water diversion during certain months of the year when the ladder would be in operation, December through April (Table 4-1). Therefore, the volume of water available for diversion to Calaveras Reservoir would also likely be reduced if a fishway was implemented. The degree to which SFPUC-proposed instream flows (Section 2.3.2.2) would be sufficient to operate a fishway, and the cost of the water in excess of the proposed flows that would be required for that purpose is addressed in this section.

---

<sup>11</sup> Cost of water cited may be a minimum cost of replacement water (water lost from storage) as it will depend on where and how SFPUC is able to replace the water. For example, recycled water development in San Francisco is estimated to cost approximately \$3,900 per acre-foot. Thus, the actual cost of replacement water will depend on replacement sources available at the time replacement water is needed.

1998 Modeled Hydrology, Wet Year

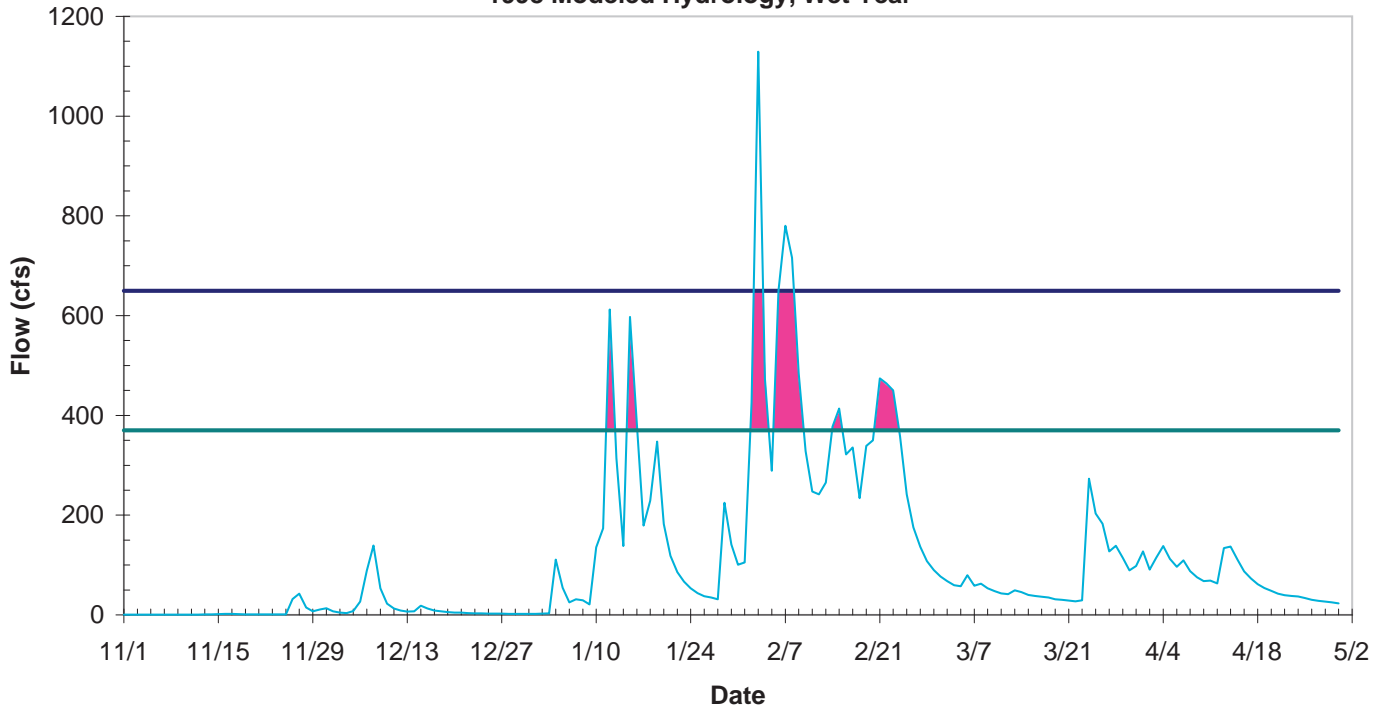

2002 Modeled Hydrology, Dry Year

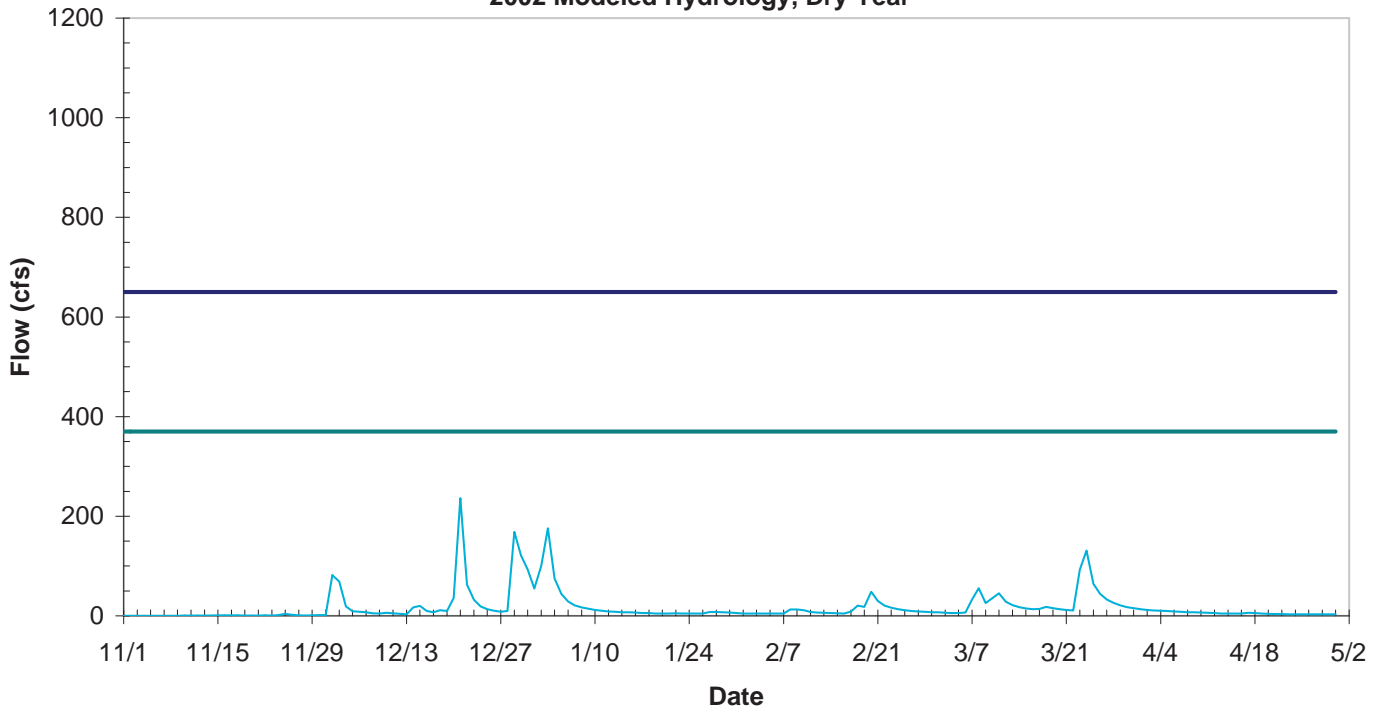

- Current Maximum Diversion
- Maximum Diversion with Screens
- Alameda Creek Predicted Flow
- Lost Water Diversion Opportunity Due to Estimated Reduction in Diversion Capacity With Screens

Potential Reduction in Diversions due to Reduced Maximum Diversion Capacity with Screens

Feasibility of Fish Passage at Alameda Creek Diversion Dam  
Technical Memorandum

June 2009

Figure 5-2

For the cost of water associated with operating the fish ladder design component, the estimated annual water cost assumes that the SFPUC-proposed normal water year instream flows will be used when they are available at ACDD during the adult immigration period of December through April. Assuming that a flow of 10 cfs is sufficient to operate the fish ladder,<sup>12</sup> opportunity costs would not be incurred when the SFPUC-proposed normal water year instream flows are bypassed between approximately January 11 and April 30. During this time period, the fish ladder flow (10 cfs) combined with the fish screen bypass flows (5 cfs) would be less than the SFPUC-proposed normal water year instream flows (Table 2-3). The water that would be bypassed at ACDD and assumed to be available for operation of screens and ladders without incurring additional cost, is shown in green on Figure 5-3.

However, from December 1 to approximately January 11, the SFPUC-proposed normal water year instream flows, along with WSIP Final PEIR mitigation flows of 10 cfs, are estimated to be insufficient to operate both a fish ladder and fish screen bypass. In that case, the water cost estimated for operation of screens and ladders includes the cost of these additional flows (shown in pink in Figure 5-3). The cost of the additional flows of up to 5 cfs that would be required from December 1 through approximately January 11, when sufficient flows are available, are applied to the annual cost of operating a fish ladder.

Similar to the analysis of reduction in diversion capacity due to screening described in Section 5.2.1, predicted daily average flows from the model described in Appendix B were used to estimate unimpaired flow for each day in the simulated period. These unimpaired flows were then used to calculate the daily difference between SFPUC-proposed normal water year instream flows and flows required for operation of a fish screen bypass and fish ladder combined, for the period from December 1 through approximately January 11 when the proposed flows would not be sufficient for operating these two design components. Based on this analysis, the additional volume of water required to operate a fish ladder at ACDD (potentially required from December 1 through approximately January 11, only when sufficient flows are available) during the simulated period of record (1969-1985 and 1996-2004) would range annually from 0 to 440 acre-feet. The estimated volume of water that would be required to operate a fish ladder is illustrated in Figure 5-3 for both a wet year and a dry year. The average annual volume of water required to operate a fish ladder, in excess of the SFPUC-proposed normal water year instream flows, is approximately 130 acre-feet. Based on the estimated 2016 water rate of \$1,500 per acre-foot, the average annual lost diversion opportunity cost associated with operation of a fish ladder to facilitate steelhead immigration is approximately \$195,000. This water cost is added to the annualized fish ladder cost in Section 5.3.

#### 5.2.4 LIMITATIONS OF WATER DIVERSION ESTIMATIONS

A number of limitations are associated with the lost water diversion opportunity costs for both screens and fishways, some of which may affect the accuracy of the estimates. Limitations with this analysis are listed below:

- Daily averages were used to model flows in Alameda Creek because those data were available, but daily average flow does not accurately represent the flashy nature of flows in Alameda Creek. Because the daily average reduces the height of the short peaks that occur in the hydrograph immediately after precipitation events, use of these data underestimates the quantity of water in excess of the diversion capacity of the ACDT that flows down Alameda Creek and over the ACDD. Use of shorter time-step data, such as 15-minute interval real-time flow data, would

---

<sup>12</sup> This estimate is based on a preliminary review of the Alameda Creek hydrograph and the Long Fishway described in Section 4.1. A more accurate estimate of flows through a fishway at ACDD would require a flow duration analysis, a storm peaking analysis, design work, and a stage discharge evaluation.

### 1998 Modeled Hydrology, Wet Year

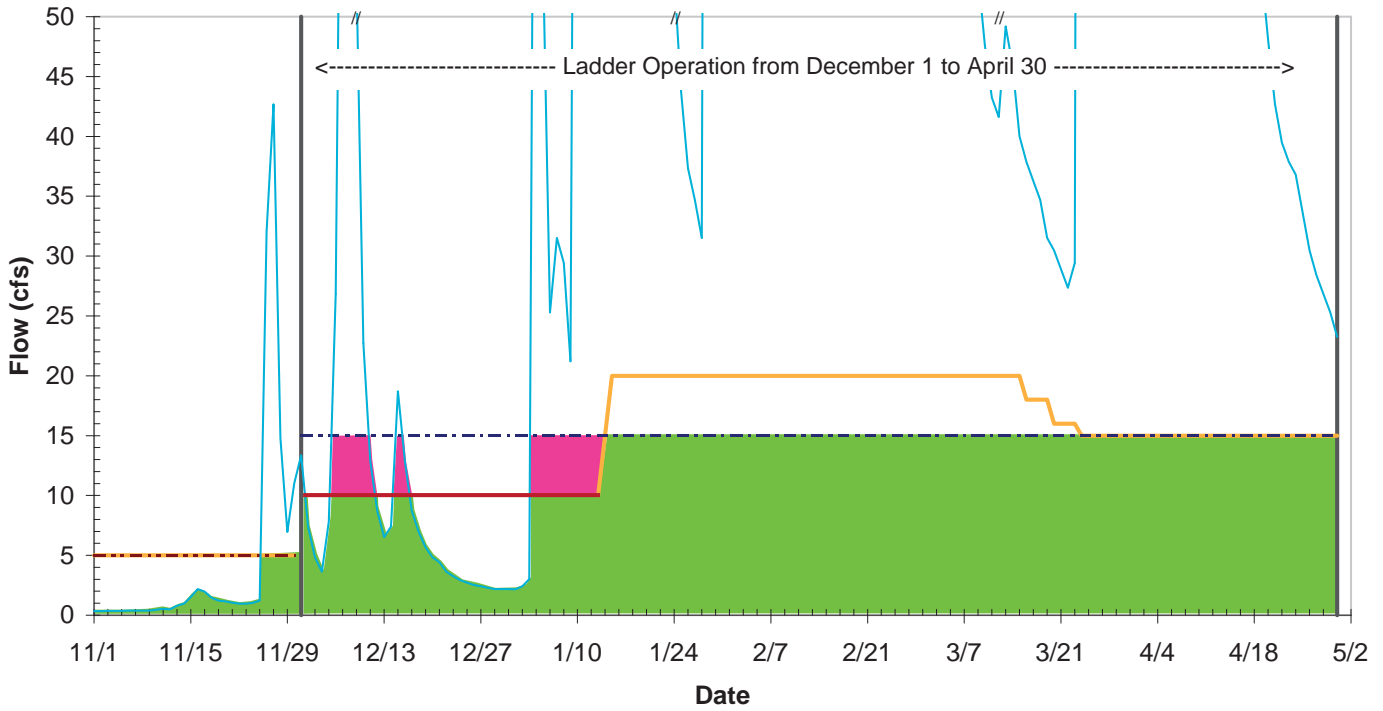

### 2002 Modeled Hydrology, Dry Year

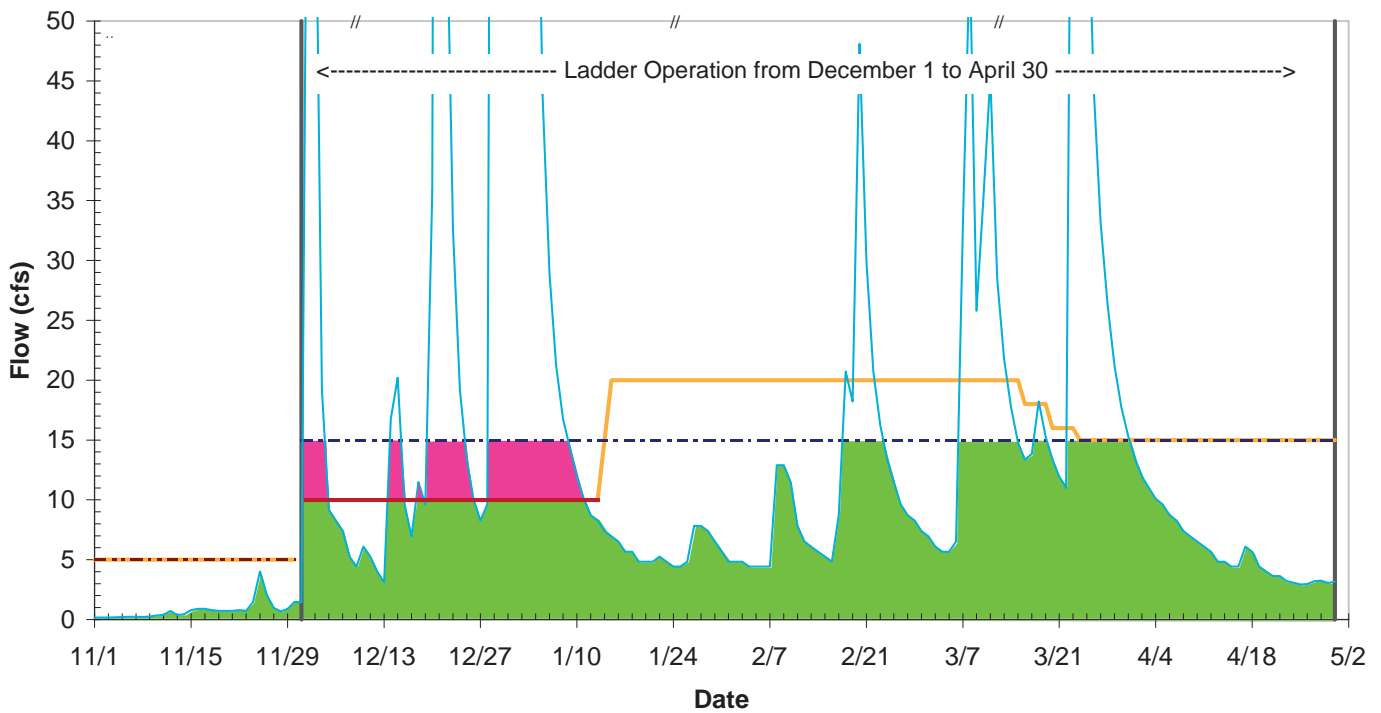

**SFPUC Proposed Instream Flow**

- Schedule B
- WSIP PEIR Mitigation Bypass

- Period of Ladder Operation
- - - Combined Screen and Ladder Flow
- - - Screen Bypass Flow
- Alameda Creek Predicted Flow

- Currently Proposed Flow (Schedule B) Assumed Available for Ladder and Screen Operation
- Additional Flow Required for Ladder and Screen Operation

**Water Potentially Required for a  
Fish Ladder and Fish Screen Bypass at ACDD**  
Feasibility of Fish Passage at Alameda Creek Diversion Dam  
Technical Memorandum

likely suggest that less water is diverted annually through the ACDT than estimated in this analysis (Table 5-2, third column). A preliminary analysis suggests that during the wettest months of a wet year the use of daily average data may overestimate diversion rates by approximately 6 percent, compared to estimates based on 15-minute interval data. During most flow conditions (dry, low, normal) there would be no difference in the diversion rate estimated using daily average data or 15-minute interval data, so the actual margin of error due to the use of daily average data is expected to be less than 6 percent.

- Potential diversion volumes calculated for both unimpaired diversions and diversion with screening represent the maximum amount of water that could have been diverted under ideal conditions. In application, actual flows to ACDT could be intermittently influenced by debris jam and other features present in real time conditions.
- Calaveras Reservoir, prior to the Division of Safety of Dams (DSOD) restriction, periodically filled to capacity and spilled. During years when the reservoir spills, there is a lack of capacity in Calaveras Reservoir to store water that could be potentially diverted from ACDD. Since the conceptual level feasibility analysis in this memorandum does not include development of a systems model to integrate historic spill scenarios, water year types, and the lost water diversion estimates in Section 5.2, the net effect of spills is not assessed in this analysis of lost water diversion costs.
- The water cost analysis is based on the assumption that the SFPUC-proposed normal water year instream flows, including WSIP Final PEIR mitigation flows, would be bypassed at the ACDD when available. The SFPUC-proposed instream flows, however, include three different flow schedules to be alternately implemented depending on the annual hydrological conditions (dry, normal, and wet) (Section 2.3.2.2). A preliminary review indicated that lost water costs at ACDD, while implementing screens, a fishway, and the normal water year flow schedule, produced results generally comparable to those that included the other flow schedules (dry and wet). Therefore use of the normal water year flow schedule was assumed to be appropriate for the level of analysis in this conceptual feasibility study.
- Because it is based on the flows predicted by the model described in Appendix B, the water cost estimate is limited by the accuracy of the model. Any inaccuracies inherent in the modeled flows are propagated to this water cost estimate.
- For the purposes of this analysis, and consistent with SFPUC's commitment to maximizing aquatic habitat under future CDRP operations (SFPUC, 2008a), it is assumed that the SFPUC-proposed flows (SFPUC, 2009b) are preferentially provided as bypass flows at ACDD whenever natural flows are present.

### 5.3 ANNUALIZED CAPITAL AND OPERATIONS AND MAINTENANCE COSTS

In this section, capital costs developed in Section 5.1 are annualized and combined with annual water costs developed in Section 5.2 and operations and maintenance costs (developed in this section) to estimate the total annualized cost of fish passage design components at ACDD. The design components are also combined to show the total estimated annualized cost of complete fish passage options at ACDD. The purpose of the preliminary cost assessment is to characterize annualized costs for design components related to fish passage that have been retained up to this point for further

consideration in this technical memorandum. The cost estimates are not as detailed as those that would be used for fiscal planning or bid solicitation, but can be used to compare the relative cost among fish passage design components.

Table 5-3 presents the estimated total annualized cost of each design component, including annualized capital costs, operations and maintenance, and associated water costs. In order to accurately compare the design component costs on an annual level, a Capital Recovery Factor (CRF) was used to convert each total capital cost into a series of equal annual costs (Cal/EPA, 1996). It is assumed that the capital costs are paid over a 30-year period at an interest rate of 5.5 percent, resulting in a CRF of 0.0688 (Table 5-3).

Order-of-magnitude operations and maintenance cost estimates were developed as part of this initial assessment of passage and screening design components (Annual O&M Allowance, Table 5-3). These estimates, detailed in Appendix A, include 0.5 percent of the total capital cost for general maintenance, as well as labor and other costs that would likely be required to operate the design components.

Annual water costs due to reduced diversion capacity with fish screens, fish screen bypass flows, and fish ladder operation flows are included as an operating cost that will be incurred each year that the facility is in operation. Hence, water costs were added to the annualized cost for design components that would incur such costs (Table 5-3). The total annualized screen and fishway costs include the annual lost water diversion opportunity costs that were developed in Section 5.2.

Design Component	Total Capital Cost	Annualized Capital Cost <sup>1</sup>	Annual O&M Allowance <sup>2</sup>	Annual Water Costs <sup>3</sup>	Total Annualized Cost
Long Fishway	\$10,502,000	\$723,000	\$114,000	\$195,000	\$1,032,000
Confluence Fish Facility	\$1,606,000	\$111,000	\$74,000	N/A	\$185,000
Camp Ohlone Haul Route	\$6,540,000	\$450,000	\$33,000	N/A	\$483,000
Fish Screens	\$13,220,000	\$910,000	\$135,000	\$2,265,000	\$3,310,000
Notes:					
<sup>1</sup> The annualized capital cost assumes a Capital Recovery Factor (Cal/EPA, 1996) of 0.0688, assuming 5.5% interest over 30 years.					
<sup>2</sup> Cost estimate presented in Appendix A, Table A-2.					
<sup>3</sup> Water costs include lost water diversion opportunity costs developed in Sections 5.1 and 5.2.					
N/A = not applicable					

In Table 5-4, design components are grouped together to identify options that provide both passage and screening (in other words, “options” are combinations of components that create complete fish passage). For example, the Ohlone Trap and Haul option would include trapping immigrating adults at the Confluence Fish Facility, hauling them upstream via the Camp Ohlone Haul Route, and releasing them above ACDD, as well as screening at ACDD.

<b>Options</b>	<b>Design Components (with annualized cost)</b>				<b>Annualized Option Cost</b>
	<b>Long Fishway (\$1,032,000)</b>	<b>Confluence Fish Facility (\$185,000)</b>	<b>Camp Ohlone Haul Route (\$483,000)</b>	<b>Fish Screen (\$3,310,000)</b>	
ACDD Fish Ladder	X			X	\$4,342,000
Ohlone Trap and Haul		X	X	X	\$3,978,000

The annualized cost of the ACDD Fish Ladder option is comparable to the Ohlone Trap and Haul option, based on the conceptual analysis carried out for this technical memorandum. Each option is retained for further evaluation to determine which is more suitable at ACDD.



## 6 ADDITIONAL CONSIDERATIONS AND ANALYSIS

This section provides a discussion of additional factors, beyond the preliminary analysis in Section 4 and the cost analysis in Section 5, that warrant consideration when evaluating design components at a conceptual level. These include estimates of the amount of habitat that the design components could provide access to, the potential for the design components to sustain a population of steelhead, and the other environmental considerations related to fish passage. Information from this section is subsequently used in Section 7, where the biological benefit of passage is analyzed.

### 6.1 HABITAT AVAILABILITY

A key consideration in assessing the opportunity for creating passage at ACDD for future steelhead is understanding habitat conditions upstream of ACDD. Detailed data regarding habitat conditions for *O. mykiss* in the Upper Alameda Creek Basin are limited and completion of habitat surveys was not within the scope of work for this conceptual feasibility analysis. This section summarizes information from available literature and knowledgeable experts.

The SFPUC's property extends only 1.5 miles upstream from ACDD. If passage was provided at ACDD, it is assumed that future steelhead would gain access to additional habitat above the extent of SFPUC's property. The Upper Alameda Creek Basin extends roughly 12 miles above ACDD, although the uppermost extent of the basin lacks suitable steelhead habitat (Figure 6-1). Based on analysis of aerial photography, the uppermost extent of Alameda Creek is highly ephemeral. An aerial survey conducted in October 2002, following a dry water year, found that of the approximately 9.4 miles surveyed between ACDD and the upper extent of Alameda Creek, 2.7 miles were dry (Entrix, 2003). At that time it was estimated that approximately 4 of the 6.7 miles of wetted channel between ACDD and the upper extent of Alameda Creek had potential to support rearing juvenile steelhead.

An on-the-ground survey conducted in August and September 2005, following an above normal water year, found that 90 percent of the reach between ACDD and Camp Ohlone was wetted (Hagar Environmental Science, 2008). The extent of the channel that remains wetted through the dry season, and the extent to which portions of the wetted channel provide suitable *O. mykiss* rearing habitat will vary annually, but during all years the extent of suitable rearing habitat will be limited to a portion of the wetted channel.

SFPUC included a portion of Alameda Creek above the confluence with Calaveras Creek, up to Camp Ohlone, in their riparian zone monitoring project. Preliminary, reconnaissance-level habitat typing data, including identification of riffles, flatwater, and pools, was conducted in 2005 (SFPUC, 2008b). Flatwater habitat accounted for almost 50 percent of the surveyed reach, with pool comprising 30 percent, and riffle 20 percent. Roughly half of the surveyed reach is below the confluence with Calaveras Creek, and therefore outside of the Upper Alameda Creek Basin and the primary study area for this memorandum.

Single-pass spawning surveys were conducted at several locations in Alameda Creek in 2006 (SFPUC, 2008c), and six additional passes were made at overlapping and nearby locations between February and April 2007 (Brian Sak, pers. comm., 2009b). Roughly 3,000 feet upstream of ACDD, an approximately 1,000-foot-long reach of Alameda Creek is dominated by exceptional spawning and rearing habitat, and one redd was observed during the single pass survey in 2006 (SFPUC, 2008c). In 2007, six redds and five diggings were observed in a 1.9-mile-long reach that begins 0.6 mile upstream of ACDD and continues upstream to near Camp Ohlone (Brian Sak, pers. comm., 2009b). The reach of Alameda Creek immediately above Camp Ohlone contains areas of suitable spawning gravel and pools with cover in the form of large woody debris and root wads (SFPUC, 2008c).

Habitat surveys were conducted in August and September 2006, to assess existing habitat conditions for *O. mykiss* in a reach of Alameda Creek that stretches upstream from Camp Ohlone for approximately 3.9 miles (Hagar and Paine, 2008). All life stages of rainbow trout were seen consistently throughout the wetted portions of the survey reach, which provide suitable spawning and rearing conditions for steelhead. Steep boulder falls present fish passage obstacles at three locations, one of which may be impassable at all but extreme high flows. The creek was intermittent beginning approximately 0.3 mile upstream of Camp Ohlone, through an alluvial valley, before surface flow reappeared approximately 1.3 miles farther upstream. A more confined reach with flow supporting rainbow trout populations continued upstream for the remaining 2.3 miles surveyed. Low summer stream flows and warm water temperatures were determined to be the most likely limiting features of habitat for salmonids in this reach.

While the above data do not provide a complete picture of habitat availability above ACDD, suitable steelhead spawning and rearing habitat is present. A fish ladder at ACDD would only succeed in providing access to upstream habitat if steelhead achieve volitional upstream passage through Little Yosemite (see Section 2.3.1 for a description of Little Yosemite). If observations of future populations of steelhead at Little Yosemite indicate that it presents a significant barrier to immigration, trap and haul could provide access above ACDD. Trap and haul would involve collecting immigrating adults below Little Yosemite at the confluence with Calaveras Creek, and releasing them above ACDD. Unless fish are also released immediately above ACDD, this could result in excluding adult steelhead from potential spawning habitat between the confluence and ACDD.

Detailed data are limited regarding habitat conditions in the approximately 3 miles of Alameda Creek that lie between the Calaveras Creek confluence and ACDD. The 2002 aerial survey described above found that 1.8 of the 3 miles were dry, and it was estimated that 1.1 of the 1.2 wetted miles had potential to support rearing juvenile steelhead (Entrix, 2003). During the SFPUC spawning surveys, no spawning fish or redds were observed in this reach, although suitable spawning gravels and adult rainbow trout were observed (SFPUC 2009c; Brian Sak, pers. comm., 2009b), and rainbow trout redds were observed in the adjacent reach of Alameda Creek immediately below the confluence with Calaveras Creek (Brian Sak, pers. comm., 2009b). Based primarily on the stream lengths, as well as the proportion of the reaches that are intermittent, and based less on the limited spawning surveys that have been conducted, it appears that spawning and rearing habitat above ACDD is more extensive than that between ACDD and the Calaveras Creek confluence.

## 6.2 POTENTIAL FOR SUSTAINABILITY

Although the primary scope of this investigation is to assess the technological feasibility of providing steelhead passage at the ACDD, a preliminary analysis of the associated potential benefit of passage is also presented (see Section 7). In this section, the potential for establishing a sustainable steelhead population in the Upper Alameda Creek Basin through provision of fish passage at ACDD is assessed qualitatively based on literature review of similar passage projects, analysis of existing data, and application of basic ecological theory. While the data required to make an accurate assessment of the potential for sustainability are not available, this rough analysis provides some preliminary indication of the potential for a steelhead population above ACDD to achieve sustainability. The assessment considered fish survival during fresh water residency, the amount of spawning and juvenile rearing habitat that passage would make accessible, the ability of adults to immigrate to newly available spawning habitat, the ability of juveniles to emigrate from upstream rearing habitat, and maintaining a minimum viable population size. Success is defined as the ability for fish passage and associated facilities to maintain a sustainable population of anadromous steelhead in the Upper Alameda Creek Basin, but the potential for passage to contribute to a steelhead metapopulation in the greater Alameda Creek Watershed is also considered.





For purposes of this technical memorandum, a sustainable steelhead population in the Upper Alameda Creek Basin is defined as having both a positive spawner replacement ratio and a minimum viable population size. The spawner replacement ratio is an estimation of the number of adult progeny that successfully return and spawn compared to the number of spawners that were used to create them. If more adult fish return in subsequent generations than were used to create them, then the replacement ratio is positive, and allowing fish passage has contributed to an overall increase in the population. If adult returns are smaller than the population used to create them, there is a net negative effect on the population and a negative contribution to overall basin production. When the replacement ratio is 1:1, the population is in equilibrium. Spawner replacement ratio is expected to vary from year to year based on various life stage survival rates. For example, exceptionally dry years could negatively impact juvenile survival and El Nino events would be expected to decrease ocean survival. Similarly, wet years could enhance juvenile survival and the ability for adults to successfully immigrate. Nevertheless, when averaged across years, a positive long-term spawner replacement ratio would be required for success.

In addition to natural fluctuations in productivity of the population, as described above, potential reductions in fish production are also associated with fish passage components. These reductions in productivity may result from reduced capture efficiencies or increased stress-related mortalities associated with the handling and transport of fish.

NMFS policy regarding recovery of listed anadromous salmonids requires use of the concept of Viable Salmonid Population (VSP), which requires establishment of abundance and productivity goals, including a long-term spawner replacement ratio of at least 1:1, as well as a minimum viable population size (NMFS, 2000 and 2008b). Shaffer (1981) states “a minimum viable population for any given species in any given habitat is the smallest isolated population having a 99 percent chance of remaining extant for 1,000 years despite the foreseeable effects of demographic, environmental, and genetic stochasticity, and natural catastrophes.” A review of the fisheries literature suggests that a minimum viable population size for Pacific salmon, including steelhead, is comprised of at least 100 breeding pairs. Emlen (1993) reports that a complete run failure for Chinook salmon occurs when the population falls below 100 breeding females. A self-sustaining population of rainbow trout in a reservoir system in British Columbia is being created with a “seed” of 100 spawning pairs of fish, based on a literature review of rainbow trout populations by Langston and Zemlak (1998). Facilitating fish passage at the ACDD could potentially produce a minimum viable population of 100 spawning pairs if sufficient adult spawning and juvenile rearing habitat is available to accommodate these fish (see Appendix C for details of this estimate).

The quantity and quality of steelhead habitat available upstream of the ACDD have not been determined. Due to the intermittent hydrology of Alameda Creek above ACDD, future steelhead numbers above ACDD may be more limited by rearing habitat than by spawning habitat. Based on limited ground surveys, topographical maps, and aerial photography, it is estimated here that approximately 4 miles (Entrix, 2003) to 10 miles (assuming an extremely wet year and suitable habitat is present in some portion of the un-surveyed tributaries of Alameda Creek above ACDD) of potential rearing habitat is available (see Section 6.1). For the purposes of this preliminary analysis it is estimated that there are between 4 and 10 miles of potential steelhead habitat (spawning and rearing habitat) above ACDD.

The number of steelhead that may be expected to spawn in the 4 to 10 miles of steelhead habitat potentially available above ACDD was approximated by evaluating the spawning densities in places where more extensive surveys have been conducted. Lagunitas Creek in Marin County provides high-quality habitat for salmonids in the San Francisco Bay area. For the past 12 years, salmon and steelhead spawning surveys have been conducted in the Lagunitas Creek watershed, which contains

about 18 miles of accessible salmonid habitat (MMWD, 2007). During most years, the watershed supports 8 to 16 steelhead redds per mile. Redds are concentrated in stream reaches where substrate and flow are favorable. Localized redd densities within favorable reaches have been observed as high as 35 redds per mile during some years. Across different watersheds, redd density is highly variable, depending on individual river and stream characteristics. Maahs and Gilleard (1993) report that for eight coastal Mendocino County streams, redd (assumed to be mostly steelhead) densities in February range from much less than 1 redd per mile up to approximately 5 redds per mile. Steelhead redd surveys in the much larger, interior Feather River of California during 2003 indicated redd counts of 36 per mile, with nearly all redds concentrated within a few miles of the river system (DWR, 2003). Based on these data, future steelhead redd density above ACDD is estimated to have a potential range from 1 to 35 per mile.

Given the above estimate of between 4 and 10 miles of potentially suitable steelhead habitat above ACDD, and the expectation of between 1 and 35 redds per mile, the habitat above ACDD may be capable of supporting between 4 (1 redd/mile  $\times$  4 miles of habitat) and 350 (35 redds/mile  $\times$  10 miles of habitat) steelhead redds annually, with the actual value likely lying somewhere in between. Based on this estimate, it may be possible for habitat above ACDD to sustain a population of steelhead (see Appendix C). If the quantity and quality of habitat above ACDD are insufficient to independently sustain a population of steelhead, then it is likely sufficient to sustain a subpopulation large enough to contribute to a steelhead metapopulation in the Alameda Creek Watershed, if subpopulations are also established at other locations.

### 6.3 ENVIRONMENTAL CONSIDERATIONS

This section summarizes non-steelhead environmental considerations including biology, wetlands, and cultural resources related to fish passage at ACDD. Construction and operation of fish passage would result in some unavoidable adverse environmental impacts. Such impacts are typical when constructing nearly any type of project in natural lands in California, and should not be considered prohibitive, but this would certainly add to the overall cost of providing fish passage. In addition to evaluating the design components as in the previous sections, the environmental impacts associated with construction and operation of the different design components also should be considered before implementing fish passage. Impacts may require permitting, minimization, and mitigation.

While the specific impacts of fish passage as evaluated in this technical memorandum would be addressed separately in specific permitting documents, the types of impacts that could potentially occur could include:

- Interference with the movement of resident fish species;
- Some localized placement of fill in jurisdictional waters of the United States, including wetlands, that are regulated under the federal Clean Water Act, to construct fish passage facilities and infrastructure;
- Limited loss or degradation of riparian habitats regulated by the CDFG under the Fish and Game Code at locations where facilities are constructed; and
- Limited loss or degradation of habitats that are potentially used by special status species (federally or state-listed, or state species of concern), including the California red-legged frog, the foothill yellow-legged frog, the California tiger salamander, and at least one species of bat at locations where facilities are constructed or roadwork is required.

The ACDD and ACDT were previously evaluated for potential inclusion in the National Register of Historic Places and the California Register of Historical Resources, and were found not to meet the criteria for listing in either case (JRP, 2008). Therefore, modifications at the ACDD would not likely affect historical properties or cause substantial adverse change to historical resources.

## 6.4 SELECTION OF PREFERRED PASSAGE DESIGN COMPONENTS

This section summarizes the remaining, viable design components based on the analyses in the preceding sections.

Viable design components evaluated for use at ACDD include screening, a fish ladder, and trap and haul. Despite the engineering challenges associated with construction of fish screens that would maintain adequate diversion capability and fish bypass flow, screening would be required if steelhead gained access above ACDD, regardless of the design components used. Therefore, screening design components as described in Section 4.4 are retained for subsequent analysis of fish passage options in this memorandum.

Installation of a fish ladder was evaluated to provide immigrating adult steelhead passage around the ACDD. Fish ladders are a proven technology for allowing passage around barriers similar in size to the ACDD. A fish ladder at ACDD would be expected to provide volitional passage with high capture efficiencies, providing nearly all adult steelhead reaching the fishway with access to habitat above ACDD without stress due to handling.

Trap and haul is also a widely used method of providing fish passage, and could be used to provide upstream passage for immigrating adult steelhead around ACDD. Passage via trap and haul would not be truly volitional, due to the need to haul the fish, and associated handling would cause stress that could increase mortality rates of adult steelhead that reach the Confluence Fish Facility. Trap and haul could bypass a substantial amount of spawning and rearing habitat between the Calaveras Creek confluence and ACDD, unless multiple fish release locations are established.

In the absence of potential immigration passage barriers at Little Yosemite, a fish ladder would be the preferred design component for providing immigrating adult steelhead with passage at ACDD. The extent to which the Little Yosemite reach is a barrier to immigration at high flows will not be completely understood until steelhead are present and attempt to immigrate past this feature. The preferred design components for providing immigrating steelhead with upstream passage at ACDD should be selected based on the ability of immigrating steelhead to reach the base of the dam.





## 7 EVALUATION OF THE BIOLOGICAL BENEFIT OF TWO PASSAGE OPTIONS

In the evaluation of passage, it is important to note that fish passage is almost always “technologically” feasible. That is, it is almost always possible to catch fish and relocate them, combined with sufficient financial investment, engineering determination, and organizational commitment. Perhaps more important is whether the cost, including the time, money, and loss of these resources for other efforts, as well as unintended effects on non-target fishes and other environmental consequences, is worth the benefits that fish passage achieves. Given that fish passage is almost always technologically feasible, it is important to focus the evaluation of fish passage on the ability or likelihood of successfully meeting the biological goals of fish passage.

As outlined in Section 3, the typical goals of fish passage are to:

- Provide access to additional quantity of habitat to increase natural production;
- Contribute to species recovery through increased overall natural production;
- Provide access to historical habitat;
- Protect or enhance the genetic integrity and/or distinctness of stocks; and
- Reduce risk of extinction through increased natural production and creation of additional independent populations.

This section examines the potential for success of fish passage for steelhead at ACDD. As described in Section 6.4, whether fish ladder design components or trap and haul design components are more appropriate for fish passage at ACDD cannot be determined with certainty until the ability of immigrating steelhead to pass Little Yosemite at high flows has been tested, or passage has been provided at that potential barrier. Therefore, both a ladder option and a trap and haul option are carried forward through this analysis, where the potential goals and success criteria for fish passage are used to evaluate the likelihood for success of each conceptual fish passage option.

### 7.1 ACDD FISH LADDER OPTION

This section evaluates the likelihood of the ACDD Fish Ladder option to meet the goals of fish passage. As identified in Section 5.3, an ACDD Fish Ladder option would include the following two design components:

- Long Fishway
- Fish Screens

Immigrating adult steelhead arriving at ACDD would enter the fishway and climb the ladder around ACDD on the right bank of Alameda Creek. Steelhead would exit the fishway upstream of ACDD. Screening at the ACDD would prevent fish from being entrained in the diversion tunnel, and a fish screen bypass would allow emigrating juveniles and post-spawn adults safe downstream passage at ACDD.

The potential for this option to meet each of the stated goals of fish passage is addressed below. The degree to which a fish ladder at ACDD would effectively pass immigrating steelhead depends largely on passage conditions at Little Yosemite. Therefore, for the analysis in this section it is assumed that immigrating steelhead are able to pass Little Yosemite, either because it is not a complete barrier to upstream migration or because passage at that barrier has otherwise been provided.

### 7.1.1 PROVIDE ACCESS TO ADDITIONAL QUANTITY OF HABITAT TO INCREASE NATURAL PRODUCTION

As described in Section 6.1, detailed data regarding the extent and suitability of steelhead spawning and rearing habitat above ACDD are limited. From what is known of the habitat above ACDD, however, it appears that there is sufficient habitat to increase natural steelhead production to levels above what could be achieved without access to this habitat. The ACDD Fish Ladder option would likely meet this goal, although future study of upstream habitat is merited, especially in conjunction with further design analysis of passage at ACDD.

### 7.1.2 CONTRIBUTE TO SPECIES RECOVERY THROUGH INCREASED NATURAL PRODUCTION

Passage design components should maximize capture efficiency and minimize stress due to handling, in order to result in a long-term spawner replacement ratio of greater than 1:1 (see Section 6.2). With the ACDD Fish Ladder option, passage-related productivity would depend primarily on ladder efficiency. Assuming the ladder is well designed, efficiency is expected to be high and losses are expected to be minimal. It is likely that this option would increase natural production, potentially contributing to species recovery.

### 7.1.3 PROVIDE ACCESS TO HISTORICAL HABITAT

Historically, the steelhead population in the Alameda Creek Watershed was probably functionally independent of populations in other watersheds (Spence et al., 2008), although population estimates are not available (Leidy et al., 2005). The presence of a possible impediment to fish migration, Little Yosemite, below ACDD in Alameda Creek (see Sections 2.3.1 and 6.1), may raise questions about the frequency at which habitat above ACDD was historically accessible to immigrating steelhead. Historic coastal steelhead populations in the Alameda Creek Watershed are adapted to streams with highly variable flow conditions, however, and steelhead populations do not need access to the ocean every year to persist (Gunther et al., 2000). The degree to which habitat above Little Yosemite (and ACDD) was historically accessible could possibly be determined by genetic evaluation of *O. mykiss* in the Alameda Creek Watershed from above and below Little Yosemite. A study of genetic diversity in *O. mykiss* populations from the Russian River basin found that fish above dams were similar to those from below-barrier sites but fish above natural barriers were highly divergent and had significantly lower genetic diversity (Deiner et al., 2007), presumably due to long-standing isolation from populations below the barriers.

### 7.1.4 PROTECT OR ENHANCE THE GENETIC INTEGRITY AND/OR DISTINCTNESS OF STOCKS

Heritable genetic variation is the basis for evolutionary change and is essential if natural selection is to operate. Genetic diversity exists at three fundamental levels: genetic variation within individuals (heterozygosity), genetic differences among individuals within a population, and genetic differences among populations. Populations can exist from an extreme of complete isolation and no genetic exchange with other populations, to the opposite extreme of free genetic exchange among populations. Meffe et al. (1997) suggest the following guidelines for genetically based conservation practices:

1. Large genetically effective population sizes are better than small ones because they will lose genetic variation more slowly.

2. The negative effects of genetic drift and inbreeding are inversely proportional to population size. Thus, avoid managing for small population sizes.
3. Management of wild populations should be consistent with the history of their genetic patterns and processes. For example, historically isolated populations should remain isolated unless other concerns dictate that gene flow must occur. Gene flow among historically connected populations should continue at historical rates, even if that calls for assisted movement of individuals.

Sufficient life-history diversity must exist to sustain a population through short-term environmental perturbations and to provide for long-term evolutionary processes. The metrics and benchmarks for evaluating the diversity of a population should be evaluated over multiple generations and include:

1. The proportion of the diversity of a life-history trait or traits that existed historically that are maintained in the existing population.
2. The historic (natural) levels and origins of gene flow and genetic diversity relative to the existing population.
3. The degree to which the existing population successfully uses available habitats.
4. The resilience of the existing population, and its ability to adapt to environmental fluctuations.

Review of the fisheries literature suggests that a minimum of 100 breeding pairs of steelhead would ensure sufficient genetic diversity for a genetically viable population (Langston and Zemplak, 1998) (see Section 6.2).

A rainbow trout population currently exists in the Upper Alameda Creek Sub-Watershed. Despite recent isolation and some stocking, the genome of the historic steelhead population is expected to be fairly well preserved in populations isolated above ACDD. Limited genetic research conducted by Nielsen (2003) suggests that this population is closely related to Central California Coast steelhead and is likely composed primarily of the isolated, historic steelhead population. Although isolation of a small population can result in genetic drift and a reduction in genetic fitness (Campbell et al., 1999), Deiner et al. (2007) report that construction of modern dams does not appear to have isolated *O. mykiss* populations for long enough to result in a loss of genetic diversity. The East Bay Regional Park District reports that private property owners have intermittently planted rainbow trout below the Ohlone section of upper Alameda Creek for 50 years prior to 1995 (Leidy et al., 2005), and the origin of these trout is unknown. Studies conducted in nearby Santa Clara Valley streams, however, suggest that stocking has had little effect on the genetic composition of most San Francisco Estuary stream *O. mykiss* (Garza and Pearse, 2008). While steelhead access to the area has been blocked for many years, rainbow trout above ACDD likely retain most of the unique genetic character of native steelhead, despite prior stocking of hatchery rainbow trout.

Facilitating fish passage could potentially introduce some out-of-basin genetic stocks to upper Alameda Creek. Considering the number of hatchery steelhead produced in the Central Valley, there is a potential for some fish from the California Central Valley DPS to stray into Alameda Creek. However, maintaining a population of at least 100 breeding pairs of steelhead in the Alameda Creek Watershed should allow for adequate within basin genetic diversity. Meffe and Carroll (1997) report that some level of gene flow among connected populations is desirable. Some low level of straying may even increase the genetic diversity and fitness of the population. Facilitating gene flow among *O. mykiss* isolated above ACDD and other *O. mykiss* populations in the Alameda Creek Watershed (through the provision of passage at ACDD and elsewhere in the watershed) may have a positive

effect on the currently isolated population's long-term genetic integrity, in turn supporting preservation of *O. mykiss* stock.

### 7.1.5 REDUCE RISK OF EXTINCTION THROUGH INCREASED NATURAL PRODUCTION AND CREATION OF ADDITIONAL INDEPENDENT POPULATIONS

Passage at ACDD could potentially create an additional, independent population of steelhead that could supplement the existing Central California Coast steelhead DPS. Passage directly above ACDD would provide access to stream habitat potentially suitable for spawning and rearing, roughly estimated to be somewhere between 4 and 10 miles based on the limited data available (see Section 6.1). As described in Section 4.4, this habitat may be sufficient to support 100 pairs of steelhead spawners, the estimated number of spawning pairs sufficient to create a sustainable population. This assertion is based on a review of available literature and imposition of professional judgment, rather than any direct quantification of spawning habitat or precise measure of current rainbow trout spawning behavior in Alameda Creek. A detailed spawning habitat survey would need to be conducted to obtain a more accurate picture of habitat availability above ACDD.

Passage at ACDD would increase steelhead habitat availability in the Alameda Creek Watershed. If steelhead are re-established at other locations in the watershed, then habitat made available by passage at ACDD would also be of integrative value to the Alameda Creek Watershed steelhead metapopulation. Historically, steelhead likely spawned in streams throughout the watershed. Access to some of these streams may have occurred intermittently, because it would have depended on annual hydrologic conditions or the state of various migration obstacles, and subpopulations within the watershed may have historically augmented each other following years of limited production in select reaches. Therefore, facilitating access to habitat upstream of ACDD could potentially augment a steelhead metapopulation in the Alameda Creek Watershed. This benefit to a metapopulation could potentially exist even if the productivity of the population above ACDD was low in some years, or was insufficient to sustain itself without contributions from other occupied habitats in the Alameda Creek Watershed.

## 7.2 OHLONE TRAP AND HAUL OPTION

This section evaluates the likelihood of the Ohlone Trap and Haul option to meet the goals of fish passage. As identified in Section 5.3, an Ohlone Trap and Haul fish passage option would include the following three design components:

- Confluence Fish Facility
- Camp Ohlone Haul Route
- Fish Screens

Immigrating adult steelhead would be captured at the Confluence Fish Facility, located at the confluence of Calaveras Creek and Alameda Creek, below Little Yosemite (Figure 4-5). Arriving fish would be transported along the Camp Ohlone Haul Route to their release point above ACDD. It may also be desirable to release some of the captured fish immediately above Little Yosemite, to access habitat between that potential barrier and ACDD. Screening at the ACDT would prevent fish from being entrained in the diversion tunnel, and a fish screen bypass would allow emigrating juveniles and post-spawn adults safe downstream passage at ACDD.

The potential for this option to meet each of the stated goals of fish passage is addressed below. In many cases, the ability of this option to meet the goals is similar to that for the ACDD Fish Ladder option described in Section 7.1. Therefore, the emphasis of the analysis in this section is on differences between this Ohlone Trap and Haul option and the ACDD Fish Ladder option.

### 7.2.1 PROVIDE ACCESS TO ADDITIONAL QUANTITY OF HABITAT TO INCREASE NATURAL PRODUCTION

Access to habitat above ACDD would be the same as with the ACDD Fish Ladder option (see Section 7.1). Because immigrating steelhead would be collected at the Confluence Fish Facility below Little Yosemite, the Ohlone Trap and Haul option could preclude steelhead access to the approximately 3 miles of Alameda Creek between its confluence with Calaveras Creek and Little Yosemite, unless multiple release locations are used. This reach's suitability, relative to habitat above ACDD, has not been well studied, but it may hold less water through the dry season than the reach above the dam (see Section 6.1). Because the habitat upstream of the dam is more extensive than that between the dam and the confluence, even if it precluded access to this 3-mile reach this option still would provide access to additional amount of habitat. With multiple release locations, this option would provide access to roughly the same habitat as the ACDD Fish Ladder option.

### 7.2.2 CONTRIBUTE TO SPECIES RECOVERY THROUGH INCREASED NATURAL PRODUCTION

Passage design components should maximize capture efficiency and minimize stress due to handling, as practicable, in order to maximize production and increase the potential for fish passage at ACDD to result in a spawner replacement ratio of greater than 1:1 (see Section 6.2). Passage-related productivity of the Ohlone Trap and Haul option would depend on ladder efficiency for the adult capture facility (expected to be less than 3 percent loss) and losses during transport (expected to be less than 1 percent loss). Additionally, capture, holding, transport and release stress could lead to increased adult pre-spawn mortality rates, after the fish have been released. With proper institutional support and funding, a well-designed, well-managed Ohlone Trap and Haul option should be able to minimize these risks, and may contribute to steelhead recovery in Alameda Creek.

### 7.2.3 PROVIDE ACCESS TO HISTORICAL HABITAT

The ability of an Ohlone Trap and Haul option to meet this goal, if multiple fish release locations were used, would be the same as discussed in Section 7.1 for an ACDD Fish Ladder option.

### 7.2.4 PROTECT OR ENHANCE THE GENETIC INTEGRITY AND/OR DISTINCTNESS OF STOCKS

The ability of an Ohlone Trap and Haul option to meet this goal would be the same as discussed in Section 7.1 for an ACDD Fish Ladder option.

### 7.2.5 REDUCE RISK OF EXTINCTION THROUGH INCREASED NATURAL PRODUCTION AND CREATION OF ADDITIONAL INDEPENDENT POPULATIONS

The ability of an Ohlone Trap and Haul option to meet this goal would largely be similar to that discussed in Section 7.1 for an ACDD Fish Ladder option. The reestablished population could

potentially be capable of sustaining itself independent of other steelhead populations. The population would be dependent upon the long-term institutional support and funding that would be required to continually capture and transport adult steelhead during the immigration period.

## 8 CONCLUSION

This technical memorandum identifies conceptual-level fish passage options at ACDD and assesses the feasibility of implementing passage to benefit steelhead when populations are restored to the Alameda Creek Watershed. The analysis finds that a fish ladder combined with installation of screens is a technologically feasible option for providing volitional passage for steelhead at ACDD. This analysis finds a fish ladder around ACDD on the right bank of Alameda Creek, in conjunction with implementing screens at ACDT and fish screen bypass flows on the left side of the dam to be the most feasible method for providing volitional passage (ACDD Fish Ladder Option, Section 7.1). The performance of a fish ladder would depend upon passage conditions for immigrating steelhead in the Little Yosemite reach of Alameda Creek (see Sections 2.3.1 and 6.1). If Little Yosemite significantly limits immigrating steelhead from reaching a fish ladder at ACDD, trap and haul from below Little Yosemite to above ACDD (Ohlone Trap and Haul Option, Section 7.2) could also provide passage, although long-term success of such passage would depend on ongoing institutional commitment and funding. Screening and fish screen bypass flows to protect steelhead from entrainment in the ACDT would be required with any type of fish passage and bypass flows would provide safe downstream passage for emigrating steelhead.

The estimated total capital cost of components associated with a fish ladder passage option and a trap and haul passage option are of a similar order of magnitude (\$23.7 and \$21.7 million, respectively), in both cases more than half of which is the estimated cost of fish screens at the ACDT (Section 5.1). Including estimated water costs, the order-of-magnitude capital and operating and maintenance cost for fish passage with screening at ACDD, annualized over a period of 30 years, is estimated at approximately \$4 million annually for either a fish ladder or trap and haul passage option. In both cases, more than \$3 million of the estimated annual cost is associated with screens. A significant portion of the annual cost of passage at the ACDD is estimated to be lost water diversion opportunity (Section 5.2).

Facilitating steelhead passage at ACDD would provide access to likely suitable steelhead spawning and juvenile rearing habitat above the diversion dam, and specific engineering solutions to provide passage are technologically feasible. Based on the limited detailed data available regarding habitat conditions in the Upper Alameda Creek Basin (see Section 6.1), it is unknown whether habitat above ACDD is sufficient to support a self-sustaining population once steelhead gain passage at the BART weir and re-enter the Upper Alameda Creek Basin. If habitat is not sufficient to support a self-sustaining population above ACDD, provision of passage could still contribute to a steelhead metapopulation in the Alameda Creek Watershed, if additional subpopulations are established in other reaches. Detailed surveys of potential steelhead habitat above ACDD, in cooperation with upstream landowners, would allow for a more accurate assessment of the potential biological benefit of steelhead passage at ACDD.

The volitional passage option of a fish ladder is generally preferred compared to non-volitional options such as trap and haul. However, it is currently not known definitively whether adequate numbers of immigrating steelhead would be able to reach the ACDD if a fish ladder was constructed. Given the substantial costs potentially associated with either passage option (see Section 5), and the uncertainty of passage conditions at Little Yosemite, it is important to understand which option would provide the greatest benefit to the species. When steelhead return to the base of Little Yosemite, it will be possible to observe and directly evaluate passage at this feature. The results of these observations could be used to refine analysis regarding providing immigration passage for steelhead at ACDD.





---

## 9 REPORT PREPARATION

### 9.1 LIST OF PREPARERS

This technical memorandum was prepared with the participation of professional scientists and engineers from URS, HDR|SWRI, HDR|FishPro's Fishery Design Center, and SFPUC.

**Paul Bratovich**, HDR|SWRI – Scientist responsible for technical review of the draft biological components of this technical memorandum.

**John Cornell**, HDR|SWRI – Associate Environmental Scientist responsible for technical research, authorship, and technical review of this memorandum.

**Edward Donahue**, HDR|FishPro – National Fisheries Technical Advisor responsible for senior technical review of this memorandum.

**Michael Garello**, HDR|FishPro – Fisheries Engineer who contributed to development of engineering and cost components, and was responsible for technical review of this memorandum.

**Samantha Hadden**, HDR|SWRI – Environmental Scientist responsible for technical support and research for biological components of this memorandum.

**Dustin Jolley**, URS Corporation – Civil Engineer contributing to fish ladder design component descriptions in this memorandum.

**Steve Leach**, URS Corporation – Senior Project Biologist responsible for task management and editorial review of this memorandum.

**David Olson**, HDR|SWRI – Scientist responsible for technical review and management of the biological components of this memorandum.

**Julie Pietrzak**, URS Corporation – Civil Engineer responsible for developing the cost estimate and screen concepts in this memorandum.

**Mike Prett**, URS Corporation – Civil Engineer responsible for evaluating the engineering and cost considerations associated with the fish passage structures in this memorandum.

**David Reel**, URS Corporation – URS Project Manager responsible for review and management of this memorandum.

**Gregory Reichert**, URS Corporation – Senior Project Engineer responsible for technical review of engineering and cost elements of this memorandum.

**William Snider**, HDR|SWRI – Fisheries Biologist supporting coordination and review of this memorandum.

**Jonathan Stead**, URS Corporation – Project Ecologist responsible for coordinating revisions to this memorandum.

## 9.2 ACKNOWLEDGMENTS

The preparers would like to acknowledge the input and field site participation of SFPUC and other City and County of San Francisco staff, third-party consultants, and resource agency staff. A partial list of these participants includes Kristine Atkinson, Jill Blanchard, Leo Bauer, David Briggs, Michael Carlin, John Chester, Cheryl Davis, Craig Freeman, Donn Furman, Paul Gambon, Marcia Grefsrud, Jeff Hagar, Mike Horvath, Janice Hutton, Dan Johnson, Ellen Levin, Steve Meirs, Josh Milstein, Joe Naras, Ryan Olah, Erik Olafsson, Tim Ramirez, Dave Rogers, Brian Sak, Jim Salerno, Steve Shaw, Gilbert Tang, and Dan Wade.

---

## 10 REFERENCES

- AACE (Association for the Advancement of Cost Engineering), 2005. International Recommended Practice No. 18R-97, Cost Estimate Classification System – As Applied in Engineering, Procurement, and Construction for the Process Industry. February 2. Available (May 2009): <http://www.aacei.org/technical/rp.shtml#18R-97>.
- ACFCWCD and ACWD (Alameda County Flood Control and Water Conservation District and Alameda County Water District), 2007. Agreement for development of preliminary design of a fish passage facility in the Alameda Creek Flood Control Channel. July 3.
- Becker, G. S., and I. J. Reining, 2008. Steelhead/rainbow trout (*Oncorhynchus mykiss*) resources south of the Golden Gate, California. Cartography by D. A. Asbury. Center for Ecosystem Management and Restoration. Oakland, California. October.
- Begon, M., J. L. Harper, and C. R. Townsend, 1996. Ecology. Third Edition. “Chapter 5.3.1, Dispersal as escape and discovery.” Blackwell Science Ltd. Malden, Massachusetts.
- Bradford, M. J., 1995. Comparative Review of Pacific Salmon Survival Rates. Volume 52.
- Burke, B. J., M. L. Moser, T. J. Bohn, L. C. Stuehrenberg, and T. C. Bjornn, 2001. Adult Fall Chinook Fishway Use: A 3-Year Summary (In Press).
- Burnham, K. P. and D. R. Anderson, 2002. Model Selection and Multimodel Inference: A Practical Information-Theoretic Approach. New York, New York: Springer Science+Business Media, Inc.
- Cada, G. F., 1996. Fish Passage Mitigation of Impacts from Hydroelectric Power Projects in the United States. Environmental Sciences Division. Oak Ridge National Laboratory. Oakridge, Tennessee.
- Cal/EPA (California Environmental Protection Agency), 1996. Economic Analysis Requirements for the Adoption of Administrative Regulations, Appendix C (Cal/EPA Guidelines for Evaluation Alternatives to Proposed Major Regulations). Memorandum from Peter M. Rooney, Undersecretary, to Cal/EPA Executive Officers and Directors. December 6.
- Campbell, N. A, J. B. Reece, and L. G. Mitchell, 1999. Biology. Fifth Edition. “Chapter 23.2, Causes of Microevolution.” Addison Wesley Longman, Inc. Menlo Park, California.
- Carmel River Watershed Conservancy, 2005. Watershed Assessment and Action Plan of the Carmel River Watershed, California. March 31.
- Carmichael, G. J. and J. R. Tomasso, 1988. Survey of Fish Transportation Equipment and Techniques. Volume 50.
- CDFG (California Department of Fish and Game), 1997. Memorandum of Understanding Between the City and County of San Francisco Public Utilities Commission and the California Department of Fish and Game Regarding Water Releases and Recapture Facilities for Purposes of Improving Native Fisheries on Alameda Creek. Sent July 25, 1997 from Brian Hunter, Region 3 Regional Manager, to Anson B. Moran, General Manager, San Francisco Public Utilities Commission.

- CDFG (California Department of Fish and Game), 2009. Fish Screening Criteria. Fisheries Engineering and Project and Information. Available (February 2009): [http://www.dfg.ca.gov/fish/Resources/Projects/Engin/Engin\\_ScreenCriteria.asp](http://www.dfg.ca.gov/fish/Resources/Projects/Engin/Engin_ScreenCriteria.asp).
- CEMAR (Center for Ecosystem Management and Restoration), 2002. Draft Steelhead Restoration Action Plan for the Alameda Creek Watershed. Prepared for the Alameda Creek Fisheries Restoration Workgroup.
- CEMAR (Center for Ecosystem Management and Restoration), 2009. Fish Passage Facility Update – December 2008. Available (February 2009): <http://www.cemar.org/alamedacreek/alamedacreek/index.html>.
- Coutant, C. C., 2001. Turbulent Attraction Flows for Guiding Juvenile Salmonids at Dams. Volume 26.
- Deiner, K., J. C. Garza, R. Coey, and D. J. Girman, 2007. Population structure and genetic diversity of trout (*Oncorhynchus mykiss*) above and below natural and man-made barriers in the Russian River, California. *Conservation Genetics* 8:437-454.
- DWR (Department of Water Resources), 2003. SP F-10, Task 2B Report 2003 Lower Feather River Steelhead (*Oncorhynchus mykiss*) Redd Survey. Oroville Facilities Relicensing FERC Project No. 2100.
- Emlen, J. M., 1993. Population Viability of the Snake River Chinook Salmon (*Oncorhynchus tshawytscha*): Recovery Issues for Threatened and Endangered Snake River Salmon, Technical Report 11 of 11. BPA Report No. DOE/BP-99654-11. Portland, Oregon: Bonneville Power Administration.
- Entrix, 2003. Aerial Survey of the Upper Alameda Creek Watershed to Assess Potential Rearing Habitat for Steelhead, Fall 2002. Prepared for the Bureau of Strategic and Systems Planning, Public Utilities Commission, City and County of San Francisco. Final Report.
- ETJV (EDAW-Turnstone Joint Venture) and ESA-Orion Joint Venture, 2008. Analysis of Potential Future Presence of Steelhead in Alameda Creek. July 7.
- Ferguson, J. W., J. G. Williams, and E. Meyer, 2002. Recommendations for Improving Fish Passage at the Stornorrforfs Power Station on the Umealven, Umea, Sweden. Seattle, Washington: National Marine Fisheries Service, Northwest Fisheries Science Center.
- Garza, J. C. and D. Pearse, 2008. Population Genetics of *Oncorhynchus mykiss* in the Santa Clara Valley Region. Final report to the Santa Clara Valley Water District. March.
- Gunther, A. J., J. Hagar, and P. Salop, 2000. An Assessment of the Potential for Restoring a Viable Steelhead Trout Population in the Alameda Creek Watershed. Prepared for the Alameda Creek Fisheries Restoration Workgroup.
- Hagar Environmental Science, 2008. Draft Calaveras Dam Replacement Fisheries Technical Report. Prepared for EDAW Turnstone Joint Venture and SFPUC. September 18.
- Hagar and Payne (Hagar Environmental Science and Thomas R. Payne and Associates), 2008. Draft Survey of Aquatic Habitat Conditions: Calaveras Creek Upstream of Calaveras Reservoir, Arroyo Hondo Upstream of the Large Slide, and Alameda Creek Upstream of Camp Ohlone. Prepared for EDAW Turnstone Joint Venture and SFPUC. October 3, 2008.

- Hayes, Darrel, 2001. Conceptual Fish Passage Designs and Cost Estimates for Lower Alameda Creek. Prepared for the Alameda County Water District, Alameda County Flood Control and Water Conservation District by CH2M Hill, January 16, 2001.
- HDR (HDR Engineering, Inc.), 2007. Evaluation and results of El Jaro Creek hydrology in relation to anticipated periods of adult and juvenile steelhead migration. Prepared for the Cachuma Conservation Release Board, September 24.
- HDR (HDR Engineering, Inc.), 2008. Draft Operation and Maintenance Manual for the San Julian Fishway. Prepared for the Cachuma Conservation Release Board, November 1, 2007.
- Healey, M. C., 1991. Life History of Chinook Salmon (*Oncorhynchus tshawytscha*) in Pacific Salmon Life Histories. Groot, C. and Margolis, L. (ed.), Vancouver, British Columbia: UBC Press, pp 311-393.
- Idaho Power Company, 2001. Feasibility of Reintroduction of Anadromous Fish Above or Within the Hells Canyon Complex Technical Report Appendix E.3.1-2 Hells Canyon Complex FERC No. 1971. J. A. Chandler, Editor.
- JRP Historical Consulting, LLC, 2008. Calaveras Dam Replacement Historic Resources Inventory and Evaluation Report. Prepared for EDAW Turnstone Consulting Joint Venture. April.
- Kahler, T. H., P. Roni, and T. P. Quinn, 2001. Summer movement and growth of juvenile anadromous salmonids in small western Washington streams. *Can. J. Fish. Aquat. Sci.* 58:1947–1956.
- Langston, A. R. and R. J. Zemlak, 1998. Simpson Lake Rainbow Trout Transplant, 1994. PFWWCP Report No. 139. Peace/Williston Fish and Wildlife Compensation Program.
- Larinier, M., 2000. Dams and Fish Migration. World Commission on Dams. Available at <http://www.dams.org/>.
- Larinier, M., 2007. Fish Lifts and Fish Locks the French Experience. GHAAPPE – Institut de Mécanique des Fluides. Avenue du Professeur Camille Soula 31400 – TOULOUSE–F.
- Leidy, R. A., G. S. Becker, and B. N. Harvey, 2005. Historical Distribution and Current Status of Steelhead/Rainbow Trout (*Oncorhynchus mykiss*) in Streams of the San Francisco Estuary, California. Center for Ecosystem Management and Restoration, Oakland, California.
- Leidy, R. A., 2007. Ecology, Assemblage Structure, Distribution, and Status of Fishes in Streams Tributary to the San Francisco Estuary, California. SFEI Contribution #530. San Francisco Estuary Institute. Oakland, California.
- Maahs, M. and J. Gilleard, 1993. Anadromous Salmonid Resources of Mendocino Coastal and Inland Rivers 1990-91 through 1991-92: An evaluation of rehabilitation efforts based on carcass recovery and spawning activity. California Department of Fish and Game, Fisheries Division, Fisheries Restoration Program, California.
- McAda, C. and B. Burdick, 2007. Colorado River Fishery Report: Annual Operation and Maintenance of the Fish Passage Structure at the Redlands Diversion Dam on the Gunnison River. Colorado Fishery Project. Grand Junction, Colorado. Recovery Program Project Number C-4b.

- Meffe, G. K. and C. R. Carroll, Contributors, 1997. Principles of Conservation Biology. Second edition. Sinauer Associates, Inc., Publishers. Sunderland, Massachusetts.
- MMWD (Marin Municipal Water District), 2007. Lagunitas Creek Salmon Spawner Report, 2006-2007. Available Online at: [http://www.marinwater.org/documents/MMWD\\_Spawner\\_06\\_07sm.pdf](http://www.marinwater.org/documents/MMWD_Spawner_06_07sm.pdf)
- Moyle, P. B. (ed.), 1976. Inland Fishes of California. Berkeley and Los Angeles, California: University of California Press.
- Moyle, P. B., 2002. Inland Fishes of California. Revised and expanded. University of California Press. Berkeley and Los Angeles, California.
- Nielsen, J. L., 2003. Population Genetic Structure of Alameda Creek Rainbow/Steelhead Trout – 2002. U.S. Geological Survey, Alaska Science Center, Anchorage, Alaska. Final report submitted to Hagar Environmental Science. December 4.
- NMFS (National Marine Fisheries Service), 1997. Fish Screening Criteria for Anadromous Salmonids. U.S. Department of Commerce, National Oceanic and Atmospheric Administration. January.
- NMFS (National Marine Fisheries Service), 2000. Recovery Planning Guidance for Technical Recovery Teams.
- NMFS (National Marine Fisheries Service), 2003. Anadromous Salmonid Passage Facility Guidelines and Criteria. Draft. Portland, Oregon: National Marine Fisheries Service, Northwest Region. Available at <http://www.nwr.noaa.gov>.
- NMFS (National Marine Fisheries Service), 2005. Final Assessment of NOAA Fisheries' Critical Habitat Analytical Review Teams For 12 Evolutionarily Significant Units of West Coast Salmon and Steelhead. Prepared by NOAA Fisheries Protected Resources Division 1201 NE Lloyd Blvd., Suite 1100, Portland, Oregon 97232-1274.
- NMFS (National Marine Fisheries Service), 2006. Endangered and Threatened Species: Final Listing Determinations for 10 Distinct Population Segments of West Coast Steelhead; Final Rule, National Oceanic and Atmospheric Administration, Department of Commerce. Federal Register 71:834-862.
- NMFS (National Marine Fisheries Service), 2008a. Anadromous Salmonid Passage Facility Design. National Marine Fisheries Service, Northwest Region. February.
- NMFS (National Marine Fisheries Service), 2008b. A Framework for Assessing the Viability of Threatened and Endangered Salmon and Steelhead in the North-Central California Coast Recovery Domain. NOAA Technical Memorandum NOAA-TM-NMFS-SWFSC-423. April 2008.
- Powers, P. D. and J. F. Orsborn, 1985. Analysis of Barriers to Upstream Migration: An Investigation of the Physical and Biological Conditions Affecting Fish Passage Success at Culverts and Waterfalls.
- Sak, B., Supervising Biologist, SFPUC Natural Resources Division, Fisheries and Wildlife Group, Sunol, California; Email Communication, Environmental Scientist, HDR, Sacramento, California; Fish Data Inquiry, April 10, 2006.
- Sak, B., San Francisco Public Utilities Commission, 2009a. Personal communication. Email correspondence with Jonathan Stead, URS Corporation. January 13.

- Sak, B., San Francisco Public Utilities Commission, 2009b. Personal communication. Email correspondence with Craig Freeman, SFPUC, titled "ACDD Passage Document: spawning surveys above ACDD to Camp Ohlone," forwarded to Jonathan Stead, URS Corporation, by Craig Freeman. January 7.
- San Jose Mercury News, 2008. After five decades, steelhead trout babies spotted in Niles Canyon watershed. May 3. Available (February 2009) at [http://www.alamedacreek.org/Media\\_Articles/San%20Jose%20Mercury%20News%205-3-08.pdf](http://www.alamedacreek.org/Media_Articles/San%20Jose%20Mercury%20News%205-3-08.pdf).
- SFEI (San Francisco Estuary Institute), 2009. Alameda Creek Watershed Sediment Forum Web Page. Available (January): <http://www.sfei.org/alamedacreek/about.html>.
- SFPD (San Francisco Planning Department), 2008. Final Program Environmental Impact Report on the San Francisco Public Utilities Commission's Water System Improvement Program. November.
- SFPUC (San Francisco Public Utilities Commission), 2004. Alameda Creek Aquatic Resource Monitoring Report, 2002. Prepared by the San Francisco Public Utilities Commission, Water Quality Bureau, Sunol, California.
- SFPUC (San Francisco Public Utilities Commission), 2006. Water System Improvement Program. January.
- SFPUC (San Francisco Public Utilities Commission), 2007. Alameda Creek Little Yosemite to Diversion Dam 2006 Wetted Channel Monitoring. Technical Memorandum No. 2-07-009. May.
- SFPUC (San Francisco Public Utilities Commission), 2008a. Memorandum Regarding Calaveras Dam Replacement Project and Alameda Creek Fishery Enhancement Project Descriptions. Sent August 19 from Ed Harrington, General Manager and Michael P. Carlin, Assistant General Manager to Diana Sokolove, Major Environmental Analysis, San Francisco Planning Department.
- SFPUC (San Francisco Public Utilities Commission), 2008b. Draft Alameda Creek and Arroyo Hondo Riparian Zone Monitoring Project Phase I Report 2005 Habitat-Typing Survey. September.
- SFPUC (San Francisco Public Utilities Commission), 2008c. Alameda Creek Aquatic Resource Monitoring Report, 2006. Prepared by the Natural Resources and Land Management Division, Fisheries and Wildlife Section, Sunol, California. January.
- SFPUC (San Francisco Public Utilities Commission), 2009a. Alameda Watershed Habitat Conservation Plan informational webpage. Available (March 2009): [http://sfwater.org/mto\\_main.cfm/MC\\_ID/20/MS\\_ID/188/MTO\\_ID/401](http://sfwater.org/mto_main.cfm/MC_ID/20/MS_ID/188/MTO_ID/401).
- SFPUC (San Francisco Public Utilities Commission), 2009b. Memorandum Regarding Proposed Instream Flow Schedules to be included in the Calaveras Dam Replacement Project Biological Assessments. Sent March 13 from Michael P. Carlin, Deputy General Manager to Harlan Kelly, Assistant General Manager, Infrastructure Division and Julie Labonte, Water System Improvement Program Director.
- SFWD (San Francisco Water District), 1995. Alameda Creek Water Resources Study.
- Shaffer, M. L., 1981. Minimum Population Sizes for Species Conservation.
- Shapovalov, L., 1953. An Evaluation of Steelhead and Salmon Management in California. Inland Fisheries Branch No. 53-4.

- Shapovalov, L. and A. C. Taft, 1954. The Life Histories of the Steelhead Rainbow Trout and Silver Salmon. State of California, Department of Fish and Game. Fish Bulletin No. 98.
- Smith, D. P., W. B. Newman, F. G. R. Watson, and J. Hameister, 2004. Physical and Hydrologic Assessment of the Carmel River Watershed, California. The Watershed Institute, California State University, Monterey Bay, Publication No. WI-2004-05/2.
- Spence, B. C., E. P. Bjorkstedt, J. C. Garza, J. J. Smith, D. G. Hankin, D. Fuller, W. Jones, E. R. Macedo, T. H. Williams, and E. Mora, 2008. A framework for assessing the viability of threatened and endangered salmon and steelhead in North-Central California Coast Recovery Domain. National Marine Fisheries Service, Southwest Fisheries Science Center. April.
- TAC (Technical Advisory Committee), 1989. "Establishment of a Steelhead Fishery in Alameda Creek." May.
- Taylor, B. L., 1995. The Reliability of Using Population Viability Analysis for Risk Classification of Species. Volume 9.
- URS (URS Corporation), 2008. CUW 37401 – CDRP Project Description for Seasonal Bypass Flows at Alameda Creek Diversion Dam. Prepared for SFPUC. January 28.
- URS (URS Corporation), 2009. Geologic Evaluation of Potential Barriers to Upstream Fish Migration in the Upper Alameda Creek Sub-Watershed. File memo from Senior Engineering Geologist David Simpson to Senior Project Biologist Steve Leach. May.
- URS and HDR, 2009a. Feasibility of Fish Passage at Calaveras Dam. Prepared for San Francisco Public Utilities Commission. June.
- URS and HDR, 2009b. Assessment of Fish Upstream Migration at Natural Barriers in the Upper Alameda Creek Sub-Watershed. Prepared for San Francisco Public Utilities Commission. In preparation.
- URS and HDR, 2009c. Assessment of Critical Riffles in Sunol Valley Quarry Reach of Alameda Creek. Prepared for San Francisco Public Utilities Commission. In preparation.
- U.S. Department of the Interior, 1995. Passageway Around the Redlands Diversion Dam and Interim Agreement to Provide Water for Endangered Fish. Bureau of Reclamation and Fish and Wildlife Service. Grand Junction, Colorado.
- USACE (U.S. Army Corps of Engineers), 1996. Feasibility of Establishing Upstream Fish Passage at Gavins Point Dam. Omaha District Preliminary Report, Omaha.
- USGS (U.S. Geological Survey), 2008. Water-Data Report 2008, 11143200 Carmel River at Robles Del Rio, California, Carmel River Basin. Available (May 2009) at: [http://waterdata.usgs.gov/nwis/nwisman/?site\\_no=11143200&agency\\_cd=USGS](http://waterdata.usgs.gov/nwis/nwisman/?site_no=11143200&agency_cd=USGS).
- USGS (U.S. Geological Survey), 2009. National Water Information System: Web Interface. USGS Gage 11172945, Alameda Creek above Diversion Dam. Downloaded from [http://waterdata.usgs.gov/ca/nwis/nwisman/?site\\_no=11172945&agency\\_cd=USGS](http://waterdata.usgs.gov/ca/nwis/nwisman/?site_no=11172945&agency_cd=USGS).
- WDFW (Washington Department of Fish and Wildlife), 2000a. Draft Fish Protection Screen Guidelines for Washington State.



- WDFW (Washington Department of Fish and Wildlife), 2000b. Fish Protection Screen Guidelines for Washington State (Draft). Funded by WDFW, SRFB, and WSDOT as part of a project developing guidelines for salmonid habitat protection and restoration. Authored by B. Nordlund and K. Bates; T. Whiley (ed.)
- WDFW (Washington Department of Fish and Wildlife), 2000c. Draft Fish Protection Screen Guidelines for Washington State.
- Wood Rodgers, 2007. Alternatives Evaluation Report, Lower Alameda Creek/BART Weir Fish Passage Assessment. Prepared for Alameda County Flood Control and Water Conservation District. December 14.
- Young, K. A., 1999. Managing the decline of Pacific salmon: metapopulation theory and artificial recolonization as ecological mitigation. *Can. J. Fish. Aquat. Sci.* 56: 1700–1706 (1999).



## Appendix A

### Cost Estimate Backup Calculations

Each fish passage design component carried forward through the preliminary analysis was analyzed further based on its cost. This appendix describes the development of raw capital costs (Table A-1) and operating and maintenance costs (Table A-2) for each design component. Raw capital cost and operating and maintenance cost assumptions are outlined on the following pages.

<b>Description</b>	<b>Cost</b>
Long Fishway	\$5,251,000
Confluence Fish Facility	\$803,000
Camp Ohlone Haul Route	\$3,270,000
Fish Screen	\$6,610,000

**Table A-1  
Summary of Capital Costs for Passage Design Components (Continued)**

ID	Description	Quantity	Unit	Unit Cost (\$)	Amount (\$)	Assumptions
<b><u>Long Fishway</u></b>						
<b>1.0</b>	<b>Fish Ladder Structure</b>					LF = 800 LF
	Fish Ladder Entrance	1	LS	150,000.00	150,000	
	Dewatering	1	LS	65,000.00	65,000	
	Excavation	950	CY	80.00	76,000	8' W x 4' H x 800 LF
	Barrier	1	LS	50,000.00	50,000	
	Base of Fish Ladder Box	360	CY	800.00	288,000	8' W x 1.5' H x 800 LF
	Side Forms of Fish Ladder Box	16,000	SF	50.00	800,000	5' x 4 sides x 800 LF
	Wall Concrete	600	CY	1,000.00	600,000	1' W x 10' H x 2 sides x 800 LF
	Cross Walls	300	CY	1,200.00	360,000	6' L x 10' H x 1' W at 6' O.C.
	Gates	1	LS	1,000,000.00	1,000,000	
	Miscellaneous Metals	1	LS	300,000.00	300,000	
	Dam Connection	1	LS	200,000.00	200,000	
	Fish Ladder Exit	1	LS	150,000.00	150,000	
<b>2.0</b>	<b>Mobilization, Overhead and Fee (O&amp;F) Allowance</b>					
	Contractor Mobilization and O&F Allowance (30%)	1	LS	1,211,700.00	1,211,700	
	<b>Total Raw Cost (March 2009 Dollars)</b>				<b>\$5,250,700</b>	

**Table A-1  
Summary of Capital Costs for Passage Design Components (Continued)**

ID	Description	Quantity	Unit	Unit Cost (\$)	Amount (\$)	Assumptions
<b>Confluence Fish Facility</b>						
<b>1.0</b>	<b>Diversion Structure</b>					
	Excavation	100	CY	80.00	8,000	10' W x 5' H x 50' L
	Dewatering	1	LS	65,000.00	65,000	
	Weir	100	CY	1,200.00	120,000	40' L x 8' H
<b>2.0</b>	<b>Fish Ladder Structure</b>					
	Excavation	55	CY	80.00	4,400	8' W x 3' H x 60' L
	Base of Fish Ladder Box	20	CY	800.00	16,000	6' W x 1.5' H x 60' L
	Side Forms of Fish Ladder Box	1,200	SF	50.00	60,000	5' x 4 sides x 60 LF
	Wall Concrete	30	CY	1,000.00	30,000	1' W x 6' H x 2 sides x 60 LF
	Cross Walls	15	CY	1,200.00	18,000	6' L x 6' H x 1' W at 6' O.C.
<b>3.0</b>	<b>Holding Pool</b>					
	Base of Holding Pool	5	CY	800.00	4,000	8' W x 1.5' H x 10' L
	Side Walls of Holding Pool	10	CY	1,000.00	10,000	4 sides x 6' H x 1' W x 10' L
	Screen Cover	1	EA	150,000.00	150,000	10' x 10' predation screen
	Flow Pipes	150	LF	150.00	22,500	24" dia. culverts
	Flow Screens	2	EA	50,000.00	100,000	
<b>4.0</b>	<b>Loading Area</b>					
	Prepare Subgrade	100	SY	30.00	3,000	
	Asphalt Surfacing Plus Base	100	SY	65.00	6,500	
<b>5.0</b>	<b>Mobilization, O&amp;F Allowance</b>					
	Contractor Mobilization and O&F Allowance (30%)	1	LS	185,220.00	185,220	
	<b>Total Raw Cost (March 2009 Dollars)</b>				<b>\$802,620</b>	

**Table A-1  
Summary of Capital Costs for Passage Design Components (Continued)**

ID	Description	Quantity	Unit	Unit Cost (\$)	Amount (\$)	Assumptions
<b><u>Camp Ohlone Haul Route</u></b>						
<b>1.0</b>	<b>Roadway</b>					Total Length = 3.1 miles
	Excavation	2,750	CY	50.00	137,500	.13 miles
	Prepare Subgrade	21,850	SY	3.00	65,550	3.1 miles long x 12' wide
	Asphalt Surfacing Plus Base	21,850	SY	65.00	1,420,250	3.1 miles long x 12' wide
	Safety	2,600	LF	15.00	39,000	Assume 0.5 mile of guardrail
	Drainage	1	LS	150,000.00	150,000	
<b>2.0</b>	<b>Transport</b>					
	Modified Full Size Pickup Truck	1	EA	60,000.00	60,000	
	Transport Tank	1	EA	4,100.00	4,100	
	Creek Access Ramp	1	LS	50,000.00	50,000	
<b>3.0</b>	<b>Mobilization, Overhead and Fee (O&amp;F) Allowance</b>					
	Contractor Mobilization and O&F Allowance (30%)	1	LS	792,705.00	792,705	
	<b>Total Raw Cost (March 2009 Dollars)</b>				<b>\$3,271,255</b>	

**Table A-1  
Summary of Capital Costs for Passage Design Components (Continued)**

ID	Description	Quantity	Unit	Unit Cost (\$)	Amount (\$)	Assumptions
<b><u>Fish Screen</u></b>						
<b>1.0</b>	<b>Fish Screen</b>					
	Flat-Plate Screen Panes	1,400	SF	1,000.00	1,400,000	Approx. 15' x 90' – Hydroscreen
	Dewatering	1	LS	65,000.00	65,000	
	Installation	1	LS	700,000.00	700,000	Assume 50% screen cost
	Brush Cleaning Mechanism	1	LS	250,000.00	250,000	
	Debris Rack	1	LS	1,000,000.00	1,000,000	
	Solar Panel (Electricity Allowance)	1	LS	300,000.00	300,000	
<b>2.0</b>	<b>Bypass Tunnel</b>					
	Demolition	1	LS	100,000.00	100,000	
	Excavation	560	CY	80.00	44,800	300' L x 10' W x 5' H
	Concrete Control Structure	60	CY	1,000.00	60,000	30' L x 5' W x 10' H
	Gates	1	LS	1,000,000.00	1,000,000	
	Channel Wall	120	CY	1,200.00	144,000	100' L x 1' W x 30' H
	Hole through Gravity Structure	30	LF	500.00	15,000	
	Tunnel	30	LF	300.00	9,000	
<b>3.0</b>	<b>Mobilization, Overhead, and Profit Allowance</b>					
	Contractor Mobilization and O&P Allowance (30%)	1	LS	1,526,340.00	1,526,340	
	<b>Total Raw Cost (March 2009 Dollars)</b>				<b>\$6,614,140</b>	

<b>Description</b>	<b>Cost</b>
Long Fishway	\$113,578
Confluence Fish Facility	\$74,324
Camp Ohlone Haul Route	\$32,700
Fish Screens	\$135,314



<b>Table A-2 Estimate of Annual O&amp;M Costs (Continued)</b>					
<b>Item</b>	<b>Quantity</b>		<b>Unit Cost</b>	<b>Amount</b>	<b>Total</b>
<b><u>Long Fishway</u></b>					
<b>Labor</b>					<b>\$61,068</b>
Maintenance person labor cost (average 3.0 hrs/day)	0.38	FTE	133,500	50,730	
Seasonal fish technician labor cost (average 3.0 hrs/day for 120-day peak immigration period)	0.12	FTE	63,900	7,668	
Annual inspections and maintenance (assume 2 people for 3 day period) labor cost	0.01	FTE	267,000	2,670	
<b>Material Costs</b>					<b>\$52,510</b>
Estimated at 0.5% of total capital cost (see Table 5-1)	0.005		10,502,000	52,510	
<b>Total Annual O&amp;M Costs</b>					<b><u>\$113,578</u></b>
<b><u>Confluence Fish Facility</u></b>					
<b>Labor</b>					<b>\$66,294</b>
Fisheries biologist labor cost (average 4.0 hrs/day for 5-month operating period)	0.21	FTE	133,500	28,035	
Driver/Maintenance person labor cost (average 4.0 hrs/day for 5-month operating period)	0.21	FTE	133,500	28,035	
Seasonal technician labor cost (average 4.0 hrs/day for 120-day peak immigration period)	0.16	FTE	63,900	10,224	
<b>Material Costs</b>					<b>\$8,030</b>
Estimated at 0.5% of total capital cost (see Table 5-1)	0.005		1,606,000	8,030	
<b>Total Annual O&amp;M Costs</b>					<b><u>\$74,324</u></b>

**Table A-2  
ACDD Passage Assessment  
Preliminary Opinion of Probable Annual O&M Costs (Continued)**

Item	Quantity	Unit Cost	Amount	Total
<b><u>Camp Ohlone Haul Route<sup>1</sup></u></b>				
<b>Material Costs</b>				<b>\$32,700</b>
Estimated at 0.5% of total capital cost (see Table 5-1)	0.005	6,540,000	32,700	
<b>Total Annual O&amp;M Costs</b>				<b><u>\$32,700</u></b>
<b><u>Fish Screens</u></b>				
<b>Labor</b>				<b>\$58,398</b>
Maintenance person labor cost (average 3.0 hrs/day)	0.38 FTE	133,500	50,730	
Seasonal fisheries technician direct labor cost (average 3.0 hrs/day for 120-day peak emigration period)	0.12 FTE	63,900	7,668	
<b>Material Costs</b>				<b>\$66,100</b>
Estimated at 0.5% of total capital cost (see Table 5-1)	0.005	13,220,000	66,100	
<b>Fuel costs (backup generators to solar power supply)</b>				
Daily fuel costs <sup>2</sup>	1	10,816	10,816	<b>\$10,816</b>
<b>Total Annual O&amp;M Costs</b>				<b><u>\$135,314</u></b>
Notes:				
Labor costs include fringe and overhead (3.0 multiplier assumed).				
FTE = Full time equivalent				
<sup>1</sup> All labor for trap and haul included in Confluence Fish Facility O&M cost estimate.				
<sup>2</sup> Back up power unit fuel cost estimate:				
<b>Item</b>	<b>Work Duration</b>	<b>Quantity (GAL)</b>	<b>Unit Cost (\$/GAL)</b>	<b>Amount</b>
Generator 1	2 hr/wk – 10 gal/hr – 52 wk/yr	1,040	5.00	5,200
Generator 2	2 hr/wk – 6 gal/hr – 52 wk/yr	624	5.00	<u>3,120</u>
			Fuel use subtotal:	8,320
			Contingency (30%):	<u>2,496</u>
			Fuel use total with contingency:	\$10,816

## Appendix B

### Arroyo Hondo – Alameda Creek Flow Model Development

At the time this model was developed, the hydrologic record for upper Alameda Creek (U.S. Geological Survey [USGS] Gage Station 11172945) extended from 1995 to 2004. This is a relatively short period of record and may not accurately characterize the temporal distribution of unimpaired flows that could potentially occur above the Alameda Creek Diversion Dam (ACDD). To more accurately predict the frequency and magnitude of unimpaired flows that could potentially be available during the diversion period (November through April), a synthetic hydrology was produced using the unimpaired mean daily flows recorded at the Arroyo Hondo gage (USGS 11173200) from 1969 to 1981 and 1995 to 2004 (no flow data are available for the 1982 through 1994 period). The purpose of this model is to estimate potential water yields from upper Alameda Creek over a broader range of hydrologic conditions by extending the period of record from 10 years to 24 years.

As would be expected in adjoining basins, the correlation between the frequency and duration of flow increases and decreases between upper Alameda Creek and Arroyo Hondo for the November-through-April period from 1995 through 2004 are similar despite differences in drainage area above the flow gages between the two watersheds (approximately 21,000 acres above the gage on Alameda Creek above ACDD and approximately 49,000 acres above the gage on Arroyo Hondo). Three distinct annual water yield volumes for upper Alameda Creek were selected to illustrate similarities in the frequency and duration of flows occurring in upper Alameda Creek and Arroyo Hondo from the November-through-April period for the 10-year period of record at the upper Alameda Creek gage. For both creeks, the lowest flows were observed in 2001, the highest flows were observed in 1998, and the second-highest flows were recorded in 1997 (Figures B-1, B-2, and B-3).

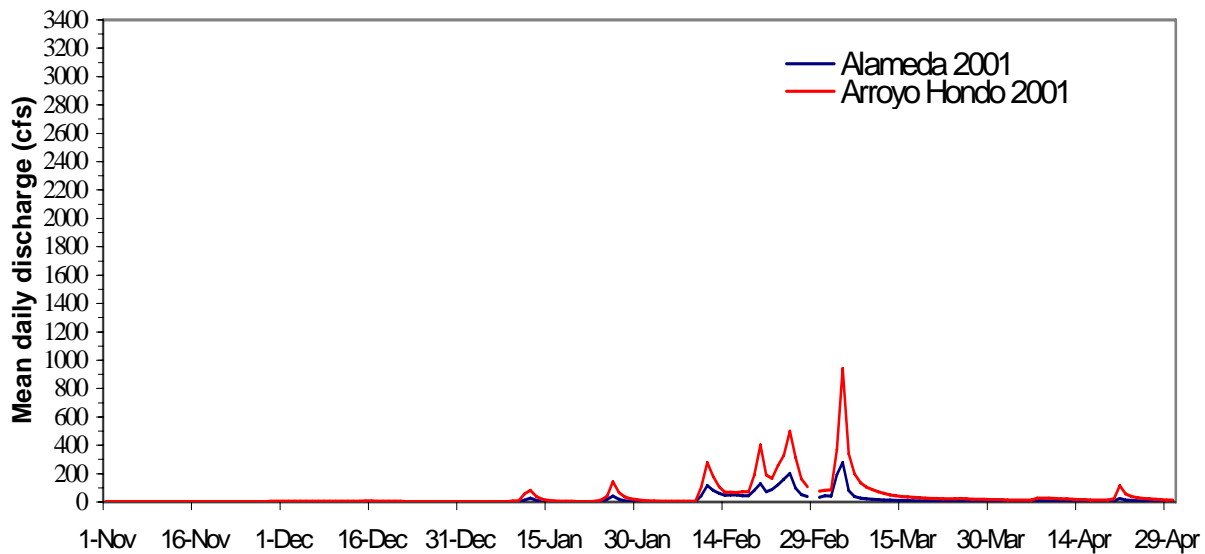

**Figure B-1** Flows Recorded at the Upper Alameda Creek Gage (USGS 11172945) and Arroyo Hondo (USGS 11173200), April through November, 2001

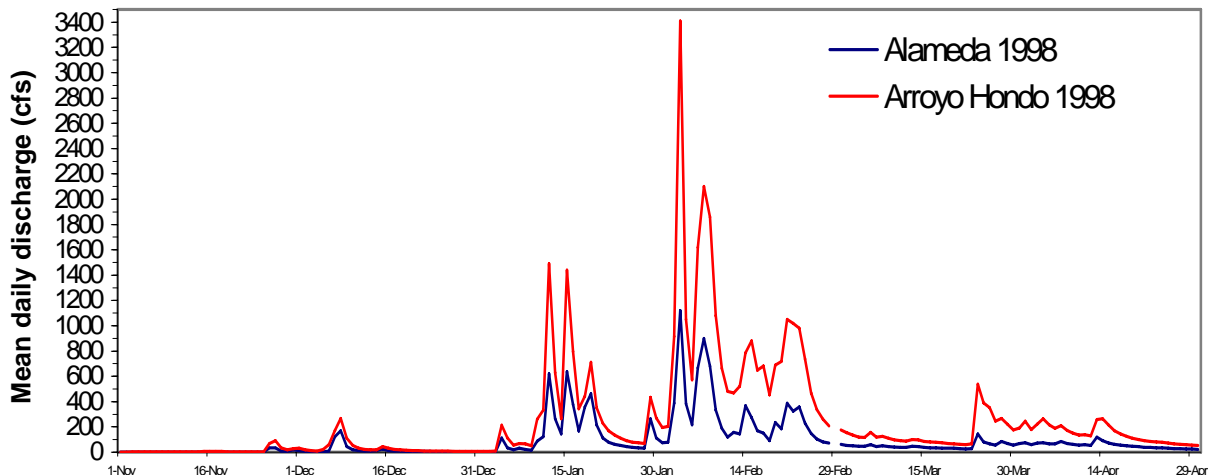

**Figure B-2** Flows Recorded at the Upper Alameda Creek Gage (USGS 11172945) and Arroyo Hondo (USGS 11173200), April through November, 1998

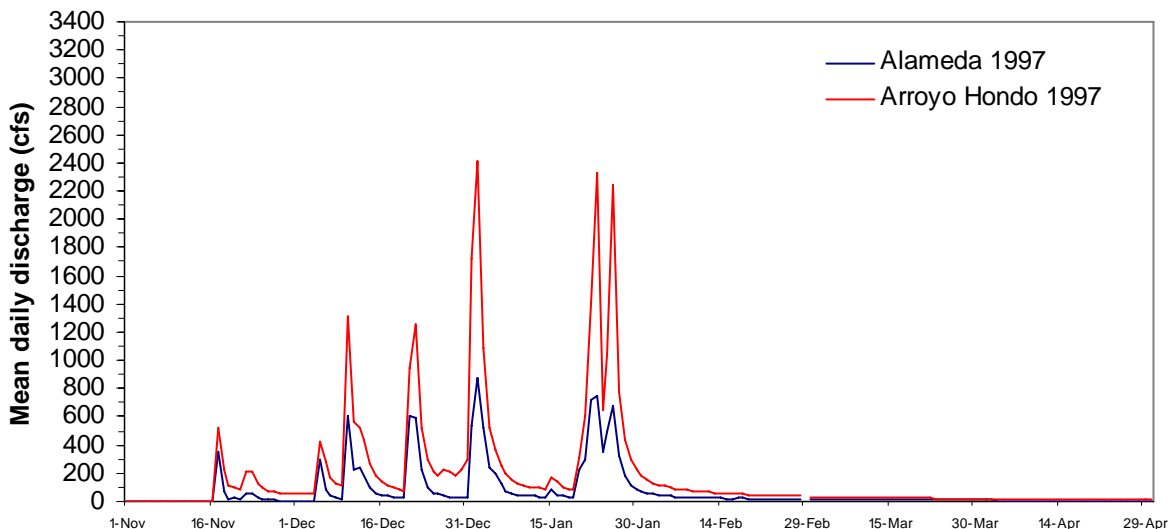

**Figure B-3** Flows Recorded at the Upper Alameda Creek Gage (USGS 11172945) and Arroyo Hondo (USGS 11173200), April through November, 1997

Alameda Creek mean daily flows (in cubic feet per second [cfs]) from USGS 11172945 were expressed as functions of Arroyo Hondo mean daily flows (cfs) from USGS 11173200 for the period 10/1/94 through 9/30/04 in which mean daily flows are available at both gages (N = 3,653). Twenty models were fitted to this data to select a “best” fit model that can be used to predict mean flows at Alameda Creek from Arroyo Hondo mean daily flows for the periods 10/1/68 through 9/30/81 and 10/1/94 through 9/30/04 (N = 8,401).

Because the range of Arroyo Hondo mean daily flows was broader during the periods 10/1/68 through 9/30/81 and 10/1/94 through 9/30/04 (i.e., 0.11 – 3,580 cfs) than during the period used in model fitting (i.e., 0.21 – 3,580 cfs), only models capable of describing the general pattern of the 1994–2004 data without predicting negative values within the 0.11 to 3,580 cfs flow range were chosen to fit to the 1994–2004 data.

Akaike’s Information Criterion (AIC) (Burnham and Anderson, 2002) was used to select the best fit out of 20 different models used to characterize the relationship between mean daily flows in Alameda Creek and

Arroyo Hondo. The deterministic components of the 20 chosen models are expressed by the following equations, where X are the Arroyo Hondo mean daily flows, and Y are the Alameda Creek mean daily flows.

Model 1:  $Y = \alpha + \beta \times X$

Model 2: 
$$Y = \begin{cases} \beta \times X, & \text{if } X \leq \frac{-\delta}{(\phi - \beta)} \\ \delta + \phi \times X, & \text{if } X > \frac{-\delta}{(\phi - \beta)} \end{cases}$$

Model 3:  $Y = \beta \times (X/1,000) + \delta \times (X/1,000)^2$

Model 4:  $Y = \beta \times (X/1,000) + \delta \times (X/1,000)^2 + \phi \times (X/1,000)^3$

Model 5:  $Y = \beta \times (X/1,000) + \delta \times (X/1,000)^2 + \phi \times (X/1,000)^3 + \gamma \times (X/1,000)^4$

Model 6:  $Y = \beta \times (X/1,000) + \delta \times (X/1,000)^2 + \phi \times (X/1,000)^3 + \gamma \times (X/1,000)^4 + \eta \times (X/1,000)^5$

Model 7:  $Y = \beta \times (X/1,000) + \delta \times (X/1,000)^2 + \phi \times (X/1,000)^3 + \gamma \times (X/1,000)^4 + \eta \times (X/1,000)^5 + \varphi \times (X/1,000)^6$

Model 8:  $Y = \alpha \times (1 - \exp(-\beta \times X))^\phi$

Model 9:  $Y = \alpha \times X \times \exp(-\beta \times X^\delta)$

Model 10:  $Y = \frac{\alpha \times X}{(1 + \beta \times X)^\delta}$

Model 11:  $Y = \frac{\alpha}{(1 + \exp(\beta - \delta \times X))^{1/\phi}}$

Model 12:  $Y = \alpha \times \exp(-\exp(\beta - \delta \times X))$

Model 13:  $Y = \alpha \times \left( 1 - \exp\left(\frac{-X^\beta}{\delta^\beta}\right) \right)$

Model 14:  $Y = \alpha - \beta \times \exp(-\delta \times X^\phi)$

Model 15:  $Y = \alpha \times X^\beta$

Model 16:  $Y = \alpha + \beta \times \ln(X + \delta)$

Model 17:  $Y = \alpha \times \left( \frac{X}{\beta + X} \right)$

Model 18:  $Y = \frac{\alpha + \beta \times X^\delta}{\phi + \gamma \times X^\eta}$

Model 19:  $Y = \alpha - \beta \times \delta^X$

Model 20:  $Y = \left( \alpha - \beta \times X^\delta \right) \times \left( 1 - \exp(-\phi \times X) \right)^\gamma$

These models were fitted to the 1994–2004 data using least squares, assuming that the residuals are normally distributed with mean 0 and standard deviation  $\sigma$ . Table B-1 displays the values of the parameter estimates, the estimated standard deviation of the residuals:

$$\left( \hat{\sigma} = \sqrt{\frac{\sum_{i=1}^N \text{residual}_i^2}{N}} \right)$$

as well as the coefficient of determination ( $r^2$ ) of the fits for the 20 models.

The best of the 20 fitted models was selected using Akaike’s Information Criteria (*AIC*). *AIC* was calculated using the formula:

$$AIC = N \times \ln(\hat{\sigma}^2) + 2 \times K \text{ (Burnham and Anderson, 2002),}$$

where  $K$  is the number of estimated parameters, and  $N$  is the sample size (i.e.,  $N = 3,653$ ).  $\hat{\sigma}^2$  was estimated as the square of  $\hat{\sigma}$ .

Table B-2 displays the *AIC* for the 20 fitted models, together with the *AIC* differences (i.e.,  $\Delta AIC_i$ ), the model likelihoods (i.e.,  $\Lambda_i$ ) and the relative model probabilities or Akaike’s weights (i.e.,  $w_i$ ). The model selected as the best model for the data out of the 20 models corresponds to the model whose fit produced the smallest *AIC*. The *AIC* differences were calculated as  $\Delta AIC_i = AIC_i - \min(AIC)$ , while the model likelihoods were calculated as:

$$L_i \propto \exp\left(-\frac{1}{2} \times \Delta AIC_i\right)$$

and the Akaike’s weights as:

$$w_i = L_i / \sum_{i=1}^{20} L_i$$

These three additional quantities provide an insight on the relative performance of each fitted model within the set of 20 chosen models.

With an AIC equal to 23,546.5, model 20 was selected as the best model of the set (Table B-2). The model 20 regression is described by the following equation:

$$Y = \left( 543.3766 + 0.00279 \times X^{1.50887} \right) \times \left( 1 - \exp(-0.00142 \times X) \right)^{1.20216},$$

with residual errors assumed to be distributed as  $\hat{\epsilon} \sim N(0, 25.05957)$ .

Figure B-4 displays the observed Alameda Creek mean daily flows as a function of the Arroyo Hondo mean daily flows in the 10/1/94–9/30/04 period (circles) together with the flows predicted by model 20 (line). The standard error,  $\sigma$ , is equal to 25.1 and the correlation coefficient,  $r^2$ , is equal to 0.92 (Table B-1).

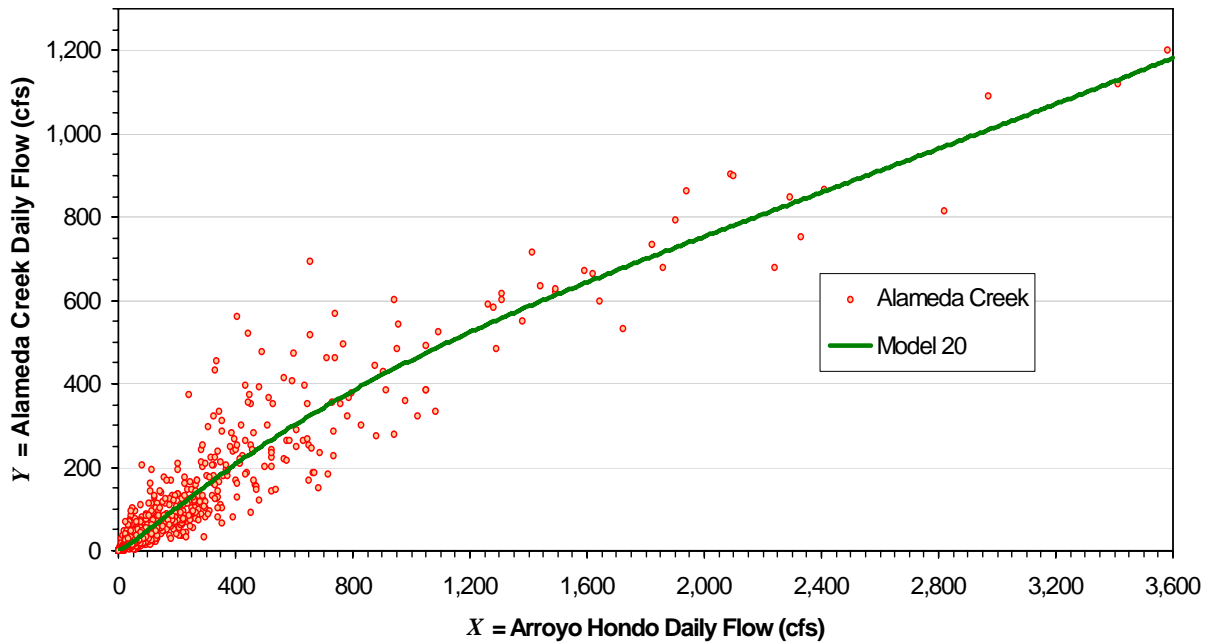

**Figure B-4 Observed Flows in Arroyo Hondo and Alameda Creeks with Model Prediction Line**

**Table B-1**  
**Parameter Estimates ( $\alpha$ ,  $\beta$ ,  $\delta$ , ...  $\phi$ ), Estimated Standard Deviation of the Residuals ( $\sigma$ )**  
**and Coefficient of Determination ( $r^2$ ) for Models 1 through 20**

Model #	1	2	3	4	5	6	7	8	9	10
$\alpha$	2.975049							1466.574	0.54162	0.543218
$\beta$	0.403938	0.50693	513.7127	545.5698	518.8926	504.6668	456.7227	0.000392	0.000452	0.000241
$\delta$		157.0493	-58.8984	-107.484	-28.5329	37.6201	361.519		0.867958	0.866488
$\phi$		0.294126		12.8433	-38.8836	-116.483	-704.497	1.033065		
$\gamma$					9.107153	41.53868	461.9796			
$\eta$						-4.38543	-132.714			
$\varphi$							13.98496			
$\sigma$	28.502	25.240	25.395	25.233	25.174	25.163	25.078	25.261	25.294	25.269
$r^2$	89.61%	91.86%	91.76%	91.86%	91.90%	91.91%	91.96%	91.84%	91.82%	91.84%
Model #	11	12	13	14	15	16	17	18	19	20
$\alpha$	759.6594	759.9175	1468.419	1447.333	1.075529	-8864.22	2711.217	0.000867	-29016.9	543.3766
$\beta$	-5.55747	1.412449	1.023939	1447.333	0.865079	1157.901	5009.693	0.000793	-29020.1	-0.00279
$\delta$	0.002533	0.002529	2620.058	0.000316		2111.945		1.33372	1.013714	1.508866
$\phi$	0.000936			1.026675				0.005707		0.001421
$\gamma$								4.75E-05		1.202162
$\eta$								0.798152		
$\varphi$										
$\sigma$	32.174	32.166	25.267	25.268	26.161	25.271	25.269	25.097	28.785	25.060
$r^2$	86.77%	86.77%	91.84%	91.84%	91.25%	91.84%	91.84%	91.95%	89.41%	91.97%



<b>Table B-2</b> <b>Number of Estimated Parameters (k), Akaike’s Information Criteria (AIC),</b> <b>AIC Differences (<math>\Delta AIC_i</math>), Model Likelihoods (<math>\Lambda_i</math>), and the Relative Model</b> <b>Probabilities or Akaike’s Weights (<math>w_i</math>) for Models 1 through 20.</b>					
<b>Model #</b>	<b>k</b>	<b>AIC</b>	<b><math>\Delta AIC_i</math></b>	<b><math>\Lambda_i</math></b>	<b><math>w_i</math></b>
1	3	24,480.9	934.4	1.2727E-203	0.000
2	4	23,594.9	48.4	3.09021E-11	0.000
3	3	23,637.8	91.3	1.51974E-20	0.000
4	4	23,592.8	46.3	8.89275E-11	0.000
5	5	23,577.7	31.2	1.69582E-07	0.000
6	6	23,576.5	30.0	3.08977E-07	0.000
7	7	23,553.9	7.4	0.024393928	0.024
8	4	23,600.9	54.4	1.52383E-12	0.000
9	4	23,610.6	64.1	1.20723E-14	0.000
10	4	23,603.2	56.7	4.78382E-13	0.000
11	5	25,370.2	1,823.7	0	0.000
12	4	25,366.4	1,819.9	0	0.000
13	4	23,602.8	56.3	5.90299E-13	0.000
14	5	23,604.9	58.4	2.04703E-13	0.000
15	3	23,854.9	308.4	1.09276E-67	0.000
16	4	23,604.0	57.5	3.22527E-13	0.000
17	3	23,601.4	54.9	1.18256E-12	0.000
18	7	23,559.5	13.0	0.00149855	0.001
19	4	24,555.2	1,008.7	9.2001E-220	0.000
20	6	23,546.5	0	1	0.975

The equation from model 20 depicted in the graph in Figure B-1 was used to produce a synthetic hydrology for upper Alameda Creek for the 1969-through-1981 and 1995-through-2004 time periods. Figures B-5 through B-14 give a graphical depiction and comparison of daily means for flows observed in Alameda Creek compared to the model-predicted flows for Alameda Creek during water years from 1995 through 2004.

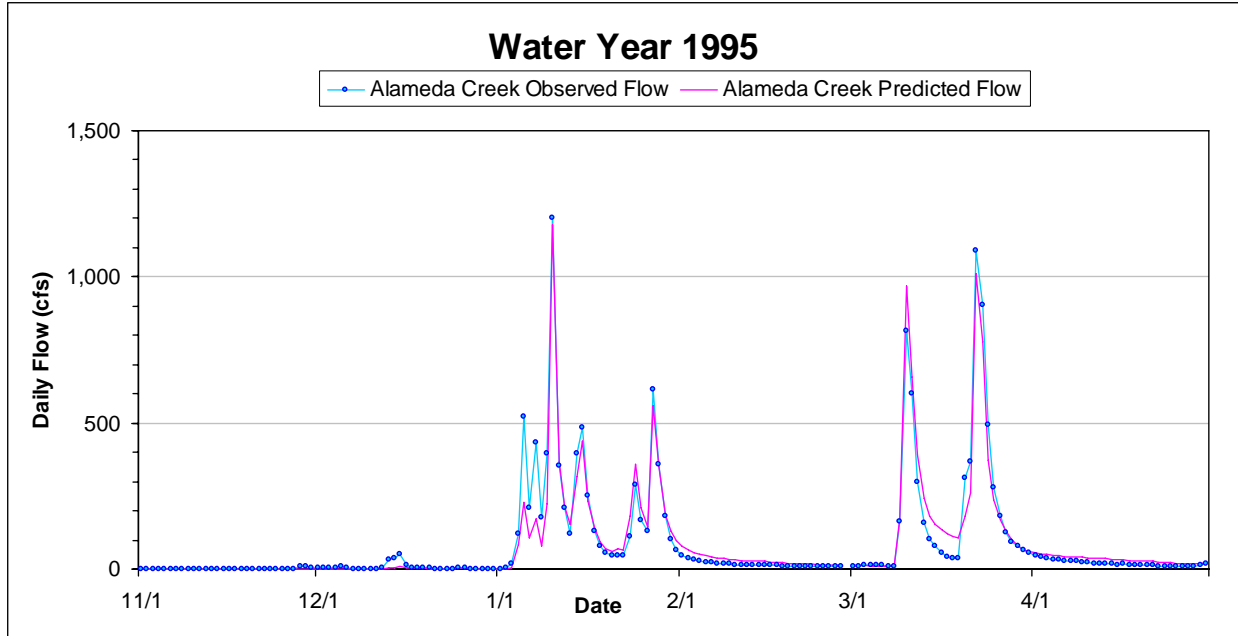

Figure B-5 Arroyo Hondo, Alameda Creek Observed Mean Daily Flows and Predicted Alameda Creek Mean Daily Flows for Water Year 1995

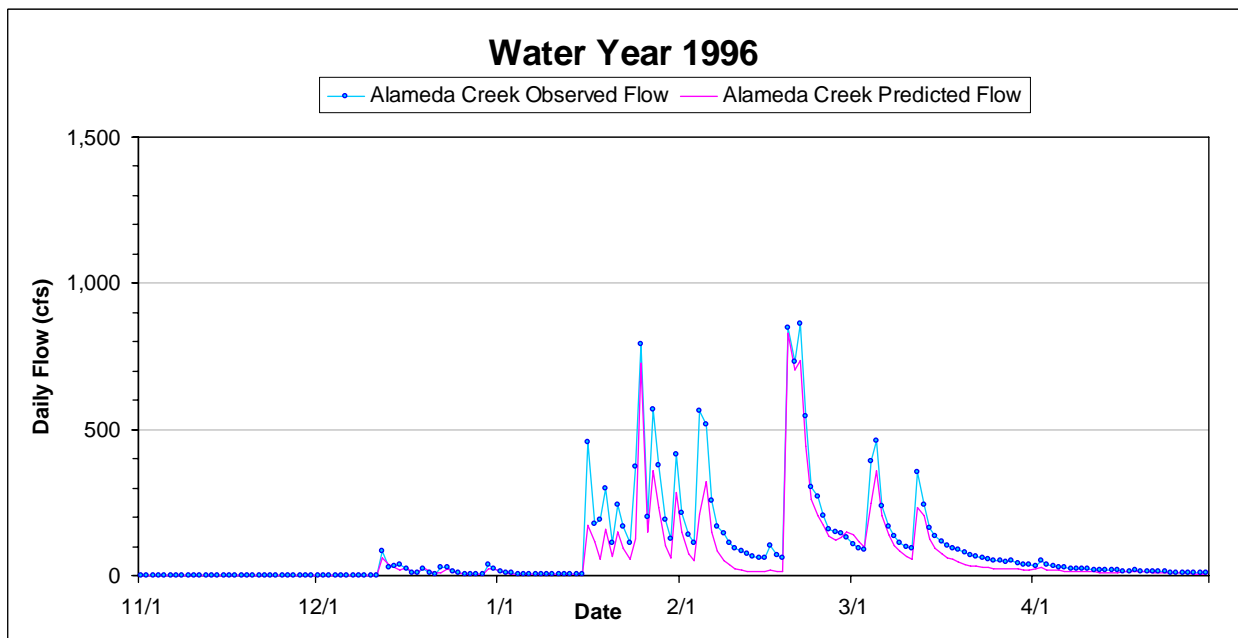

Figure B-6 Arroyo Hondo, Alameda Creek Observed Mean Daily Flows and Predicted Alameda Creek Mean Daily Flows for Water Year 1996

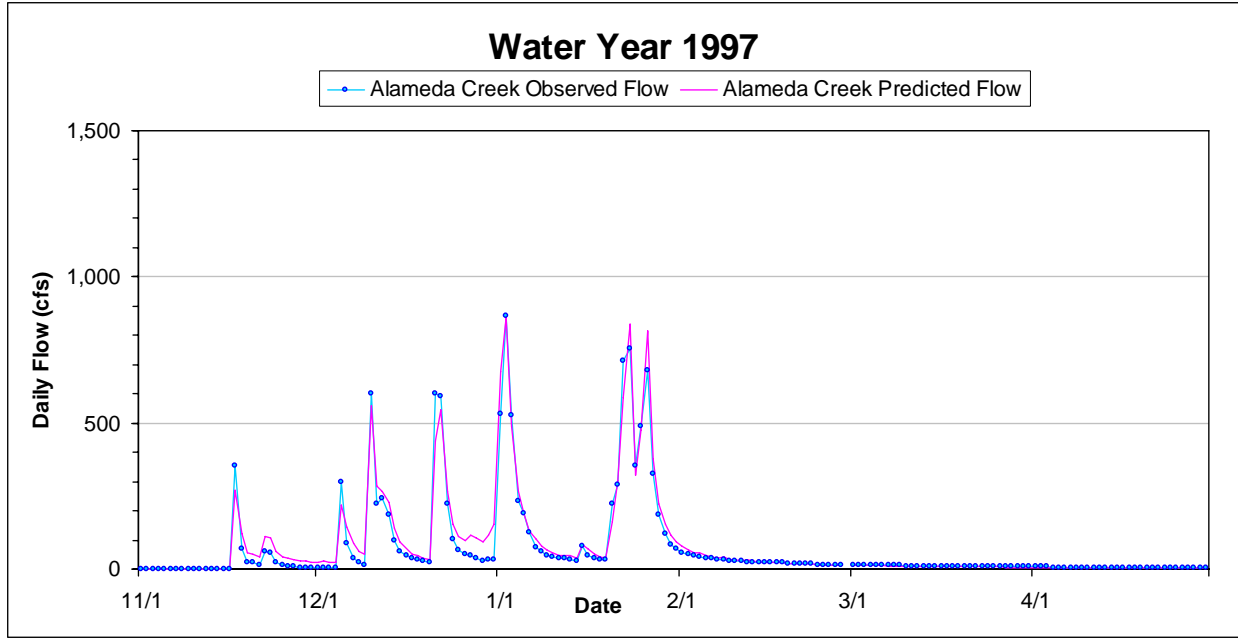

Figure B-7 Arroyo Hondo, Alameda Creek Observed Mean Daily Flows and Predicted Alameda Creek Mean Daily Flows for Water Year 1997

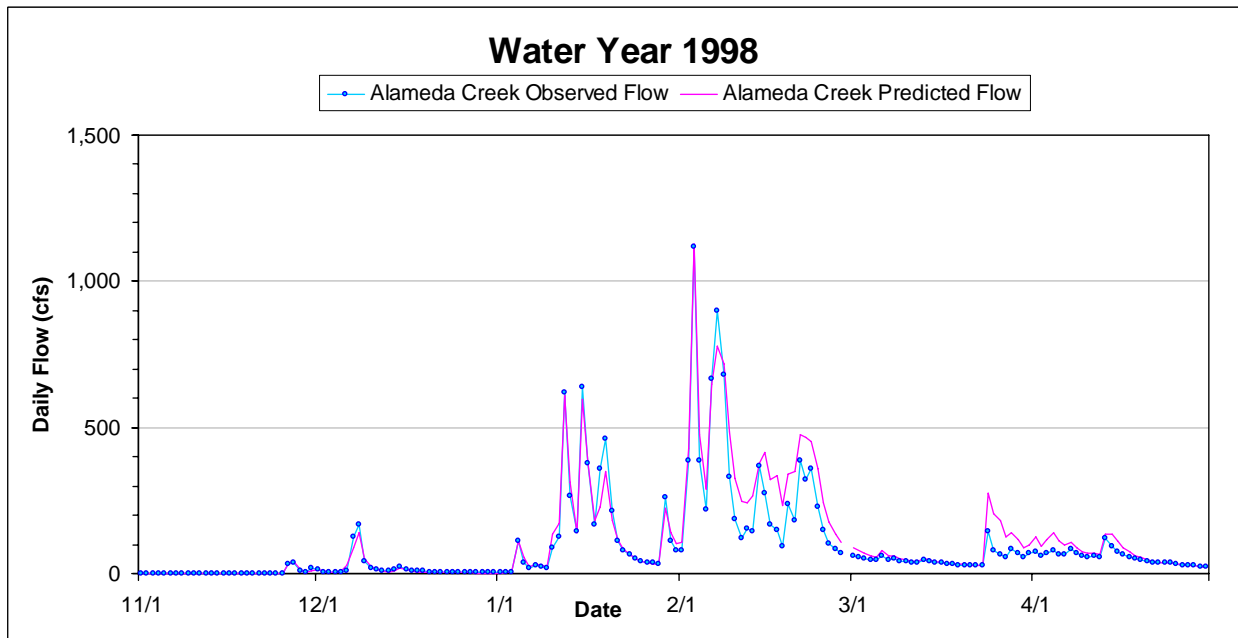

Figure B-8 Arroyo Hondo, Alameda Creek Observed Mean Daily Flows and Predicted Alameda Creek Mean Daily Flows for Water Year 1998

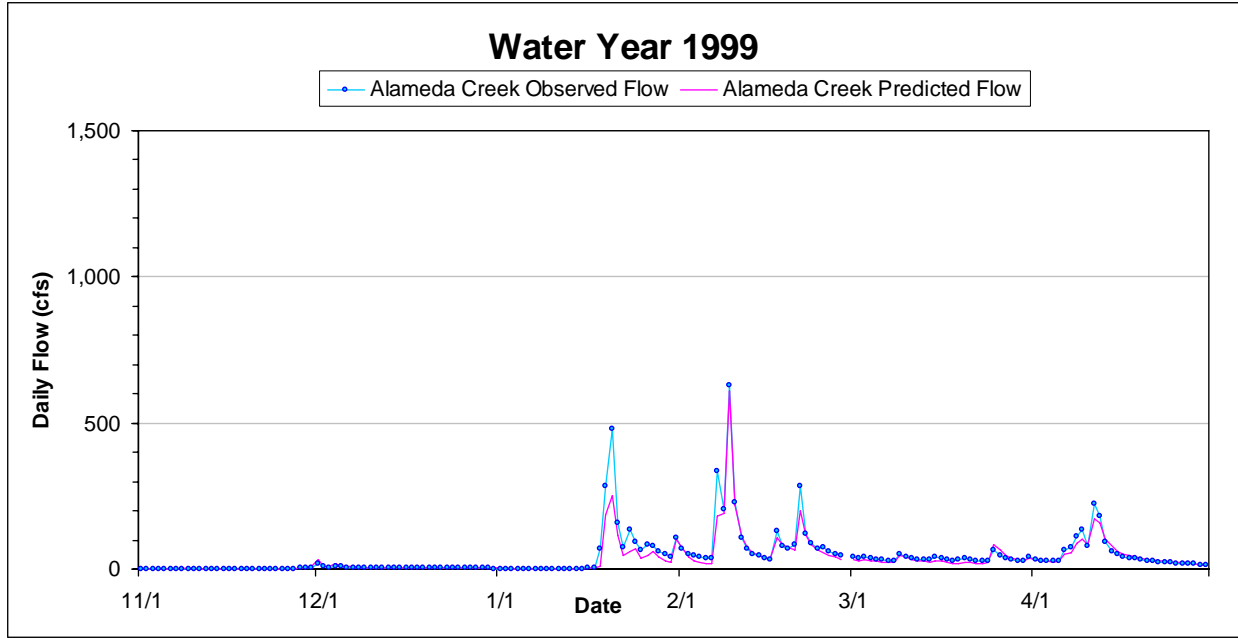

Figure B-9 Arroyo Hondo, Alameda Creek Observed Mean Daily Flows and Predicted Alameda Creek Mean Daily Flows for Water Year 1999

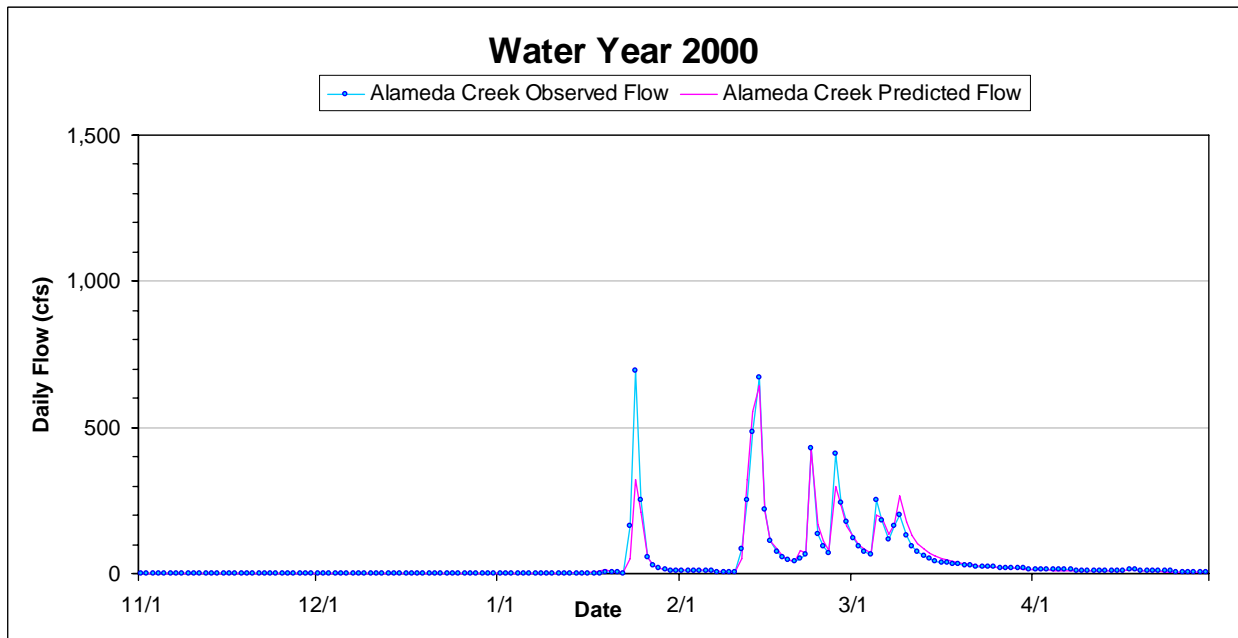

Figure B-10 Arroyo Hondo, Alameda Creek Observed Mean Daily Flows and Predicted Alameda Creek Mean Daily Flows for Water Year 2000

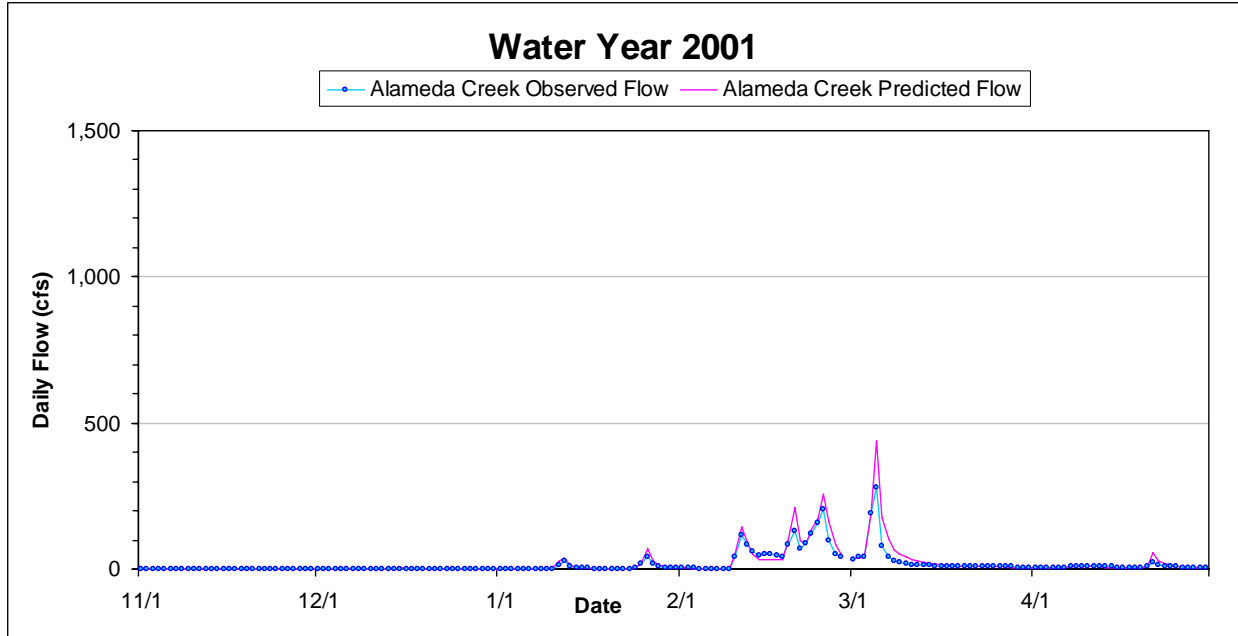

Figure B-11 Arroyo Hondo, Alameda Creek Observed Mean Daily Flows and Predicted Alameda Creek Mean Daily Flows for Water Year 2001

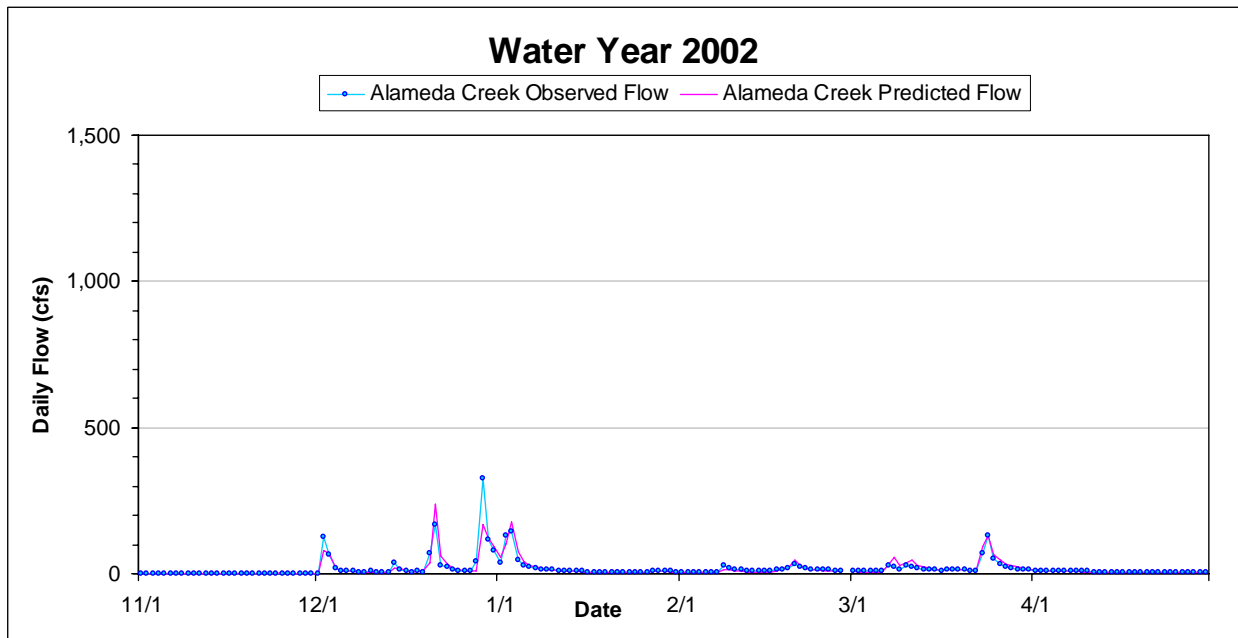

Figure B-12 Arroyo Hondo, Alameda Creek Observed Mean Daily Flows and Predicted Alameda Creek Mean Daily Flows for Water Year 2002

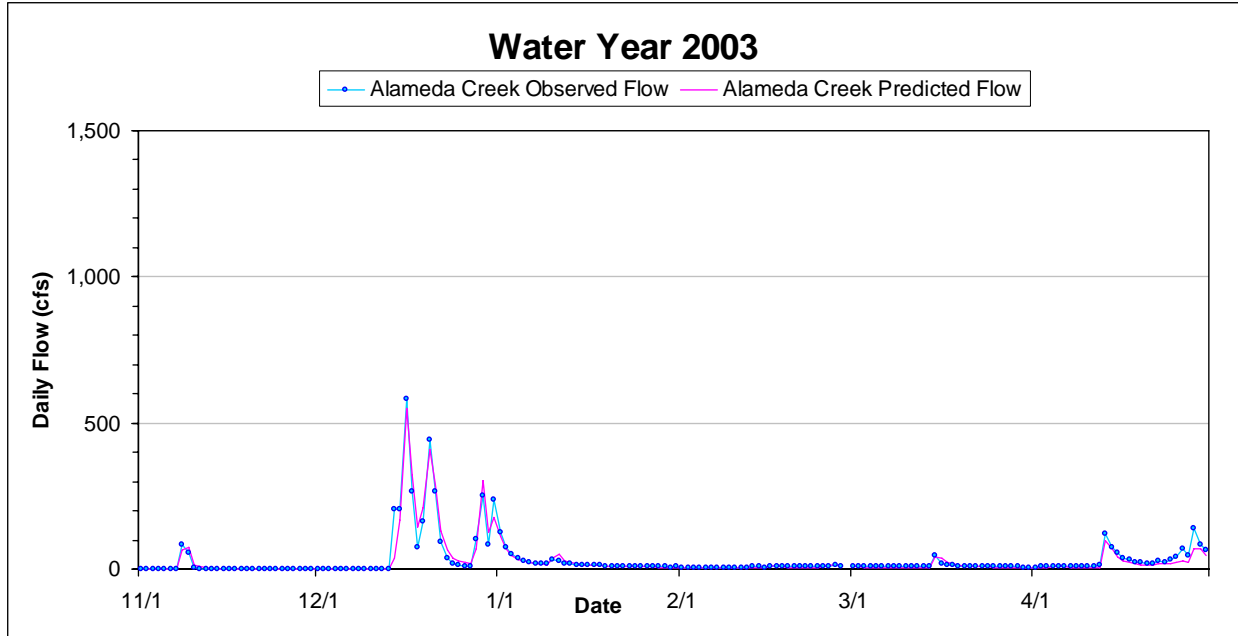

Figure B-13 Arroyo Hondo, Alameda Creek Observed Mean Daily Flows and Predicted Alameda Creek Mean Daily Flows for Water Year 2003

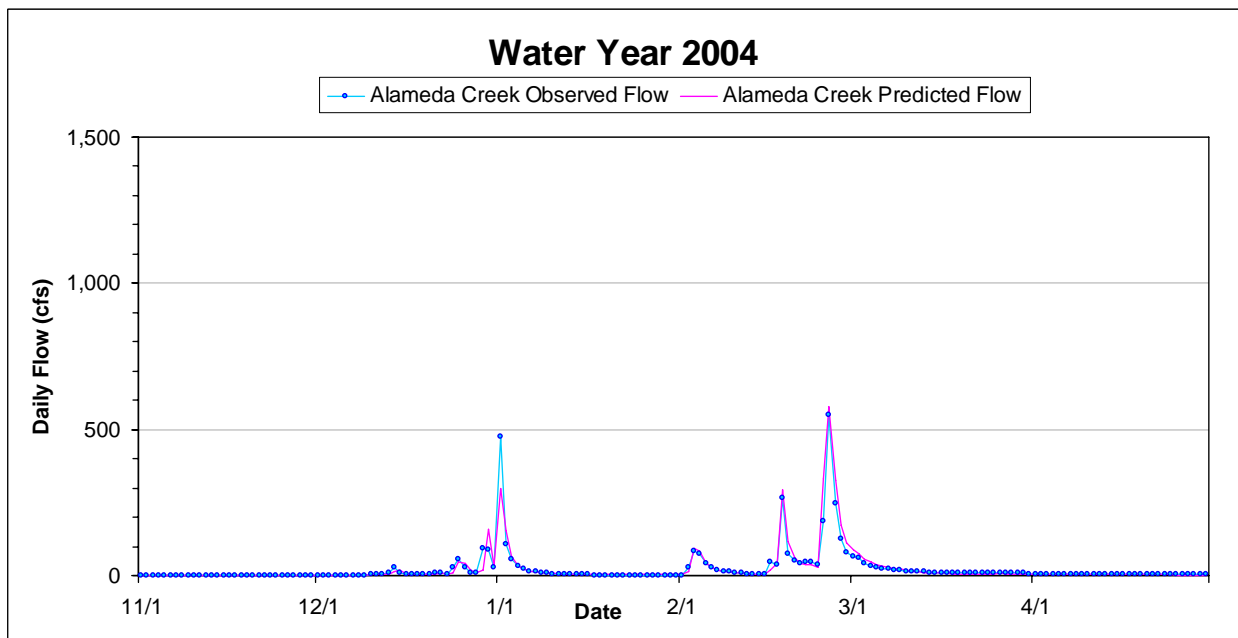

Figure B-14 Arroyo Hondo, Alameda Creek Observed Mean Daily Flows and Predicted Alameda Creek Mean Daily Flows for Water Year 2004

## Appendix C

### Technical Information on Minimum Viable Population Size

Ecologists have developed several models to determine minimum viable population sizes. These models have been characterized as population viability analyses. The basic model used to characterize population growth is

$$N_{t+1} = \lambda N_t \quad (1)$$

where,

$N_{t+1}$  is the estimated population size in the next generation;  $\lambda$  is the rate of population growth; and  $N_t$  is the number of breeding pairs currently in the population (i.e., initial population size). If  $\lambda=1$  the population is stable, if  $\lambda<1$  the population is declining, and if  $\lambda>1$  the population is growing (Taylor, 1995).

For salmonids, the growth rate of the population,  $\lambda$ , is dependent upon the proportion of individuals surviving from one life stage to the next, and can be expressed as

$$\lambda = E \cdot S_1 \cdot S_2 \cdot S_3^y \cdot S_4 \quad (2)$$

where,

$E$  = Eggs produced from previous generation

$S_1$  = Egg to fry survival

$S_2$  = Fry to smolt survival

$S_3$  = Annual ocean survival

$y$  = Years in ocean (since steelhead will spend at least 2 years at sea,  $y = 2$ )

$S_4$  = migration to spawning ground survival

Life stage survival rates reported in the literature can be used to estimate  $\lambda$ ; however, they are highly variable due to differences in inherited traits between populations as well as natural and anthropogenic environmental disturbances. For example, Moyle (1976) reports numbers of eggs ranging from 200 to 12,000 per adult female, but the number is generally found to be around 2,000 eggs per kilogram of adult body weight.

If conservative assumptions are made for values of variables used to estimate the growth rate of the population,  $\lambda$ , it is possible to estimate the number of adults that could potentially return if there was enough spawning habitat to support 100 breeding females,  $N_b$ , in the upstream tributaries of Calaveras Reservoir. One hundred female steelhead producing at least 2,000 eggs per kilogram of body weight (weighing a minimum of 2.5 kilograms) could reportedly produce a total of 5,000 fertilized eggs,  $E$ .

Estimates for egg to fry survival rates reported by Healey (1991) range from 14 to 94 percent in Chinook salmon. Bradford (1995) reviewed the literature on Pacific salmon survival and reports an average egg to smolt survival of 7 percent. Healey (1991) reports average ocean survival rates of 20 to 36 percent annually.

Based on other values reported in the literature, it is assumed that the egg to fry survival rate,  $S_1$ , is 14 percent; ocean survival,  $S_3$  is 20 percent per year; and that migration to spawning ground survival,  $S_4$  is a product of both the reported 80 percent, and an estimated 90 percent survival rate from handling and transport through facilities and devices. Using these estimates for survival during key life stages and equations (1) and (2), the number of returning adults from initial population of at least 100 breeding pairs (i.e., 100 females) can be estimated as,

$$N_{t+1} = [(5,000) \cdot (0.14) \cdot (.07) \cdot (0.20^2) \cdot (0.80) \cdot (0.90)] \cdot 100 = 141$$

Of the estimated 141 returning adults produced from the initial 100 females, it is uncertain what proportion would be male or female. However, if we assume that the sex ratio is 1:1 there would be approximately 70 females to produce eggs for the next generation. However, since the rate of population growth,  $\lambda$ , is dependent only on life stage survival rates, the number of individuals in the population would continue to increase (i.e.,  $\lambda = 1.41$ ).

These generalized estimates are presented to illustrate that, in theory, fish passage at ACDD could potentially produce a sufficient number of returning adults if sufficient adult spawning and juvenile rearing habitat is available to accommodate 100 breeding pairs.